

# **SICOM3024G Industrial Ethernet Switch**

## **Hardware Installation Manual**

Publication Date: Sep. 2016

Version: V1.0

No.:

***KYLAND***

## **SICOM3024G Industrial Ethernet Switch**

### **Hardware Installation Manual**

**Disclaimer:** Kyland Technology Co., Ltd. tries to keep the content of this manual as accurate and as updated as possible. This document is not guaranteed to be error-free, and we reserve the right to amend it without notice to users.

**All rights reserved.**

No part of this documentation may be excerpted, reproduced, translated, annotated or duplicated, in any form or by any means without the prior written permission of KYLAND Corporation.

**Copyright © 2016 Kyland Technology Co., Ltd.**

## Notice for Safety Operation

The product performs reliably as long as it is used according to the guidance. Artificial damage or destruction of the device should be avoided. Before using the device, read this manual carefully for personal and equipment safety. Please keep the manual for further reference. Kyland is not liable to any personal or equipment damage caused by violation of this notice.

- Do not place the device near water sources or damp areas. Keep the ambient relative humidity within the range from 5% to 95% (non-condensing).
- Do not place the device in an environment with high magnetic field, strong shock, or high temperature. Keep the working and storage temperatures within the allowed range.
- Install and place the device securely and firmly.
- Please keep the device clean; if necessary, wipe it with a soft cotton cloth.
- Do not place any irrelevant materials on the device or cables. Ensure adequate heat dissipation and tidy cable layout without knots.
- Wear antistatic gloves or take other protective measures when operating the device.
- Avoid any exposed metal wires because they may be oxidized or electrified.
- Install the device in accordance with related national and local regulations.
- Before power-on, make sure the power supply is within the allowed range of the device. High voltage may damage the device.
- Power connectors and other connectors should be firmly interconnected.
- Do not plug in or out the power supply with wet hands. When the device is powered on, do not touch the device or any parts with wet hands.
- Before operating a device connected to a power cable, remove all jewelry (such as rings, bracelets, watches, and necklaces) or any other metal objects, because they may cause electric shock or burns.
- Do not operate the device or connect or disconnect cables during an electrical storm.
- Use compatible connectors and cables. If you are not sure, contact our sales or technical support personnel for confirmation.

- Do not disassemble the device by yourself. When an anomaly occurs, contact our sales or technical support personnel.
- If any part is lost, contact our sales or technical support personnel to purchase the substitute. Do not purchase parts from other channels.
- Dispose of the device in accordance with relevant national provisions, preventing environmental pollution.

In the following cases, please immediately shut down your power supply and contact your Kyland representative:

- Water gets into the equipment.
- Equipment damage or shell damage.
- Equipment operation or performance has abnormally changed.
- The equipment emits odor, smoke or abnormal noise.

# Contents

1 Product Overview .....	1
2 Structure and Interface .....	2
2.1 Front Panel .....	2
2.2 Rear Panel .....	2
3 Switch Installation.....	4
3.1 Dimension Drawing.....	4
3.2 Mounting Modes and Steps .....	4
4 Cable Connection .....	7
4.1 10/100/1000Base-T(X) Ethernet port .....	7
4.2 1000Base-X, 10/100/1000Base-T(X) SFP Slot .....	8
4.2.1 Gigabit SFP Optical Module .....	9
4.2.2 Gigabit SFP Electrical Module.....	10
4.3 1000Base-X, 10/100/1000Base-T(X) Combo port.....	10
4.4 Console Port .....	11
4.5 Grounding .....	12
4.6 Power Terminal Block .....	13
4.7 Alarm Terminal Block.....	14
5 LEDs.....	15
6 Switch Access .....	18
6.1 Access through Console Port.....	18
6.2 Access through Telnet .....	20
6.3 Access through Web .....	20
7 Basic Features and Specifications.....	22

# 1 Product Overview

SICOM3024G includes a series of managed industrial Ethernet switches tailored for power, rail transit. Capable of working properly in rugged environment, SICOM3024G conforms to IEC61850-3 and IEEE1613 standards.

The series switches support 19 inch 1U rack mounting by front/rear panel.

Table 1 Models

Models	SICOM3024G-C-Ports1 -PS1-PS2
Code definition	Code option
C	This model support anti-corrosion coating
Ports1: S/M, T	12G12GE
	<p><b>Note:</b></p> <p><i>12G12GE: twelve 1000Base-X, 10/100/1000Base-T(X)Combo ports, twelve 10/100/1000Base-T(X) ports.</i></p>
PS1: power input 1	HV (220AC/DCW)
PS2: power input 2	HV (220AC/DCW), N/A



**Note:**

We reserve the right to amend the product information listed in the table above without notice. To obtain the latest information, contact our sales or technical support personnel.

## 2 Structure and Interface



**Caution:**

It is recommended to purchase the port dustproof shield (optional) to keep ports clean and ensure switch performance.

### 2.1 Front Panel

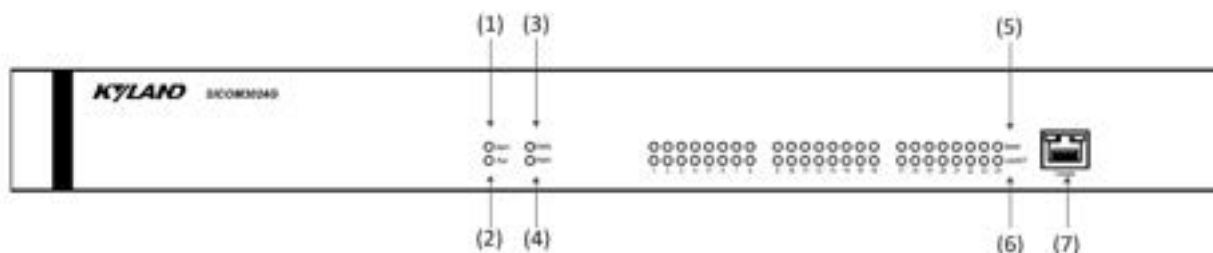

Figure 1 Front Panel

Table 2 Description of Front Panel

No.	Identifier	Description
(1)	Alarm	Alarm LED
(2)	Run	Running LED
(3)	PWR2	Power 2 LED
(4)	PWR1	Power 1 LED
(5)	(1-24)Speed	Twenty-four 1000M Ethernet port speed LEDs
(6)	(1-24)Link/ACT Link/ACT	Twenty-four 1000M Ethernet port connection status LEDs
(7)	Console	Console port

### 2.2 Rear Panel

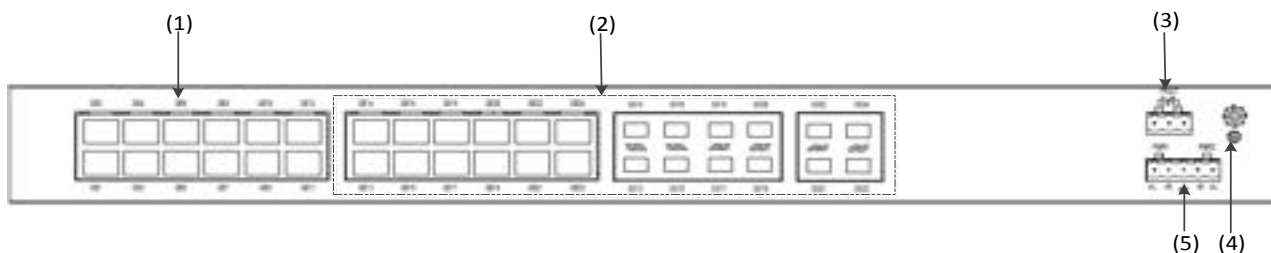



Figure 2 Rear Panel

Table 3 Description of Rear Panel

No.	Identifier	Description
(1)	GE(1-12)	Twelve 10/100/1000Base-T(X)Ethernet port
(2)	GX/GE(13-24)	Twelve 1000Base-X, 10/100/1000Base-T(X)Combo ports
(3)	FAULT	Alarm terminal block
(4)		Grounding screw
(5)	PWR1/PWR2	Power terminal block



### 3 Switch Installation

#### 3.1 Dimension Drawing

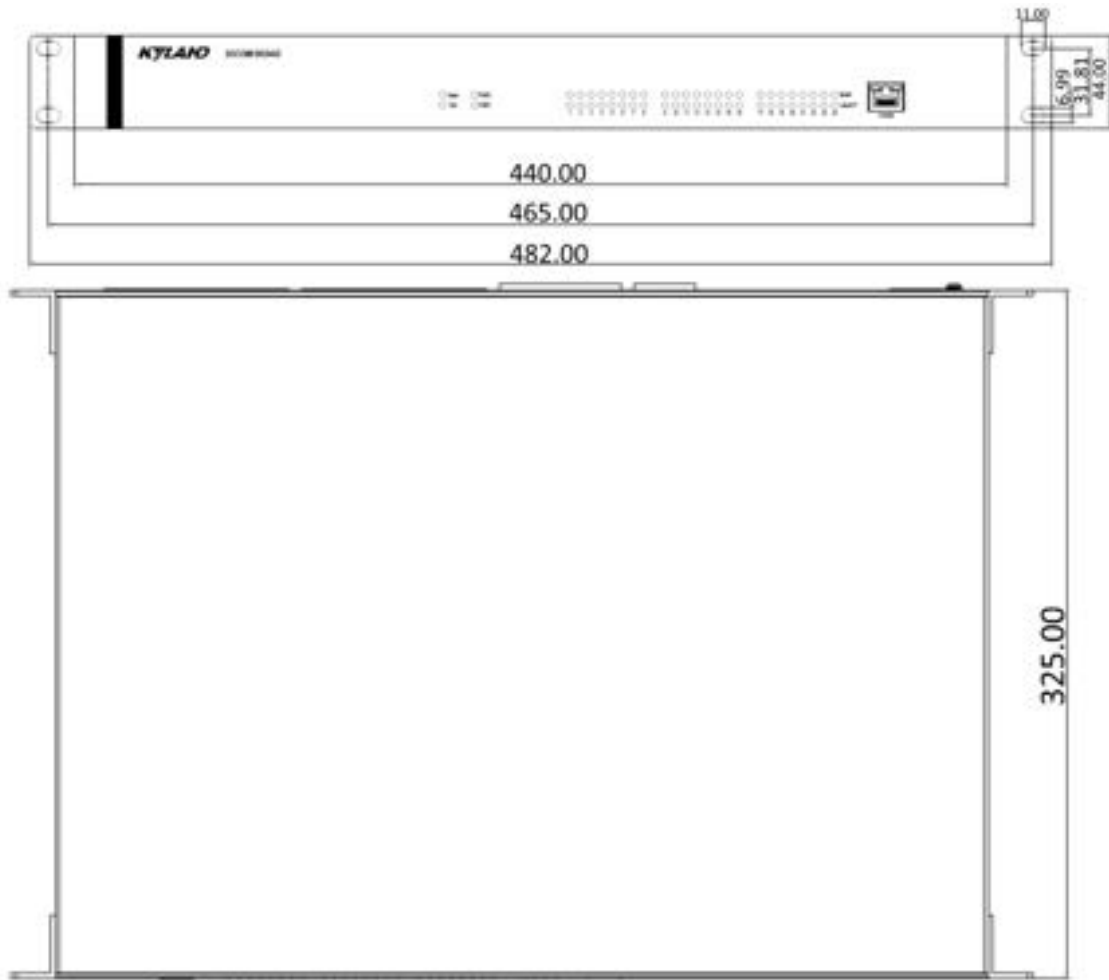

Figure 3 Dimension Drawing (unit: mm)



**Caution:**

- As part of the heat dissipation system, the switch housing becomes hot during operation. Please use caution when coming in contact and avoid covering the switch housing when the switch is running.
- The figures in this chapter are only for reference.

#### 3.2 Mounting Modes and Steps

The series switches support rack mounting by front/rear panel. The following uses mounting

by front panel as an example to describe mounting steps. The steps for mounting by rear panel are similar to those for mounting by front panel. Before installation, make sure that the following requirements are met.

- 1) Environment: temperature (-20°C ~ +60°C), ambient relative humidity (5% to 95%, non-condensing)
- 2) Power requirement: The power input is within the voltage range of the switch.
- 3) Grounding resistance: <math><5\Omega</math>
- 4) No direct sunlight, distant from heat source and areas with strong electromagnetic interference.
- 5) Devices are to be installed in an authority certified enclosure and accessible only by the use of a tool.
- 6) Devices should be installed and accessed by service personnel or users who have been instructed about the reasons for the restrictions applied to the location and about any precautions that shall be taken.

● Installing Mounting Brackets

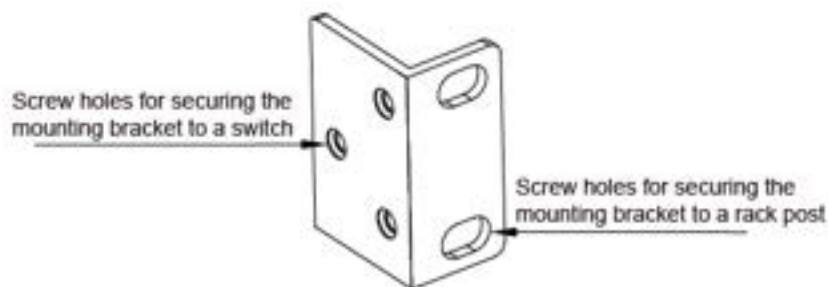

Figure 4 Mounting Bracket

You can select the screw holes for front or rear panel mounting to install the mounting brackets. There is a group of screw holes on the front and rear panels on both sides of the device respectively. In each group of screw holes, three large screw holes (M4) are used to install the mounting brackets, other small screw holes (M3) are used to fasten gaskets. If there are screws inserted in screw holes (M4), remove the screws and keep them for future use.

As shown in the following figure, use three screws to secure two mounting brackets to the switch respectively.

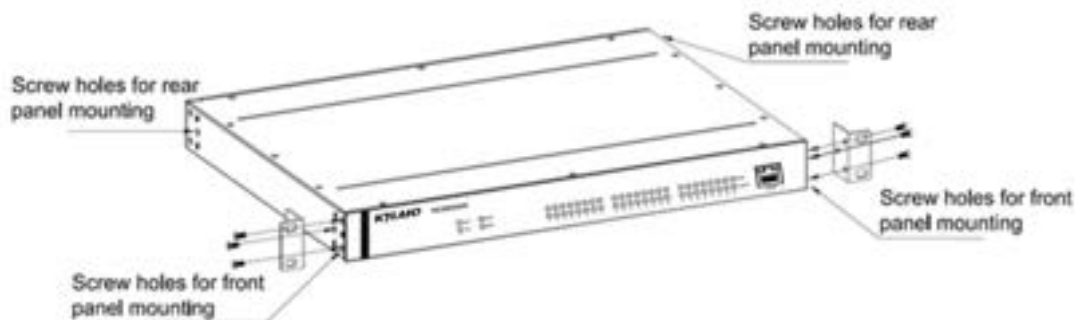

Figure 5 Installing Mounting Brackets

● Mounting

Step 1: Select the mounting position for the device and guarantee adequate space and heat dissipation for it (dimensions: 440mm×44mm×325mm).

Step 2: Move the switch in direction 1 until the screw holes for securing the mounting brackets to rack posts are in alignment with the corresponding holes in the rack posts. Then use four screws and supporting captive nuts to secure the mounting brackets to the rack posts.

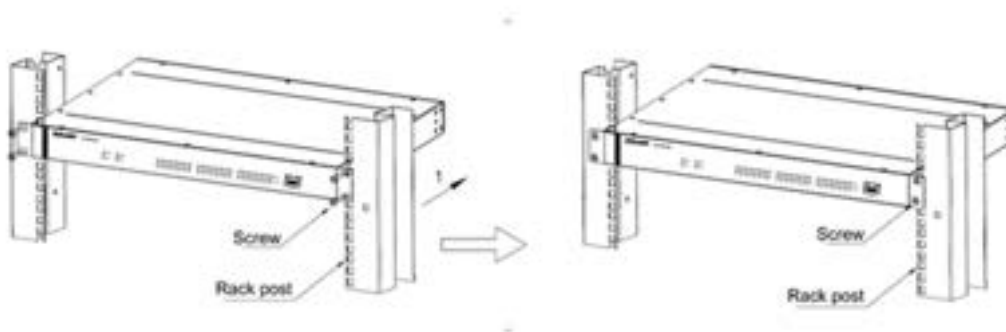

Figure 6 Mounting by Front Panel

● Dismounting

Step 1: Remove the four screws and supporting captive nuts securing the mounting brackets to the rack posts.

Step 2: Remove the switch from the rack posts. Then unscrew the mounting brackets to complete dismounting.

## 4 Cable Connection

### 4.1 10/100/1000Base-T(X) Ethernet port

10/100/1000Base-T(X) Ethernet port is equipped with RJ45 connector. The port is self-adaptive. It can automatically configure itself to work in 10M, 100M, or 1000M state, full or half duplex mode. The port can also adapt to MDI or MDI-X connection automatically. You can connect the port to a terminal or network device with a straight-through or cross-over cable.

- Pin Definition

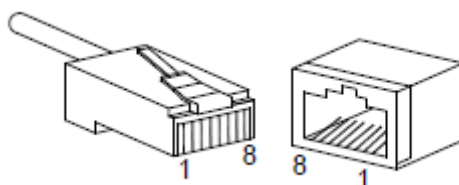

Figure 7 RJ45 Port

Table 1 Pin Definitions of 10/100/1000Base-T(X) RJ45 Port

Pin	MDI-X	MDI
1	Transmit/Receive Data (TRD1+)	Transmit/Receive Data (TRD0+)
2	Transmit/Receive Data (TRD1-)	Transmit/Receive Data (TRD0-)
3	Transmit/Receive Data (TRD0+)	Transmit/Receive Data (TRD1+)
4	Transmit/Receive Data (TRD3+)	Transmit/Receive Data (TRD2+)
5	Transmit/Receive Data (TRD3-)	Transmit/Receive Data (TRD2-)
6	Transmit/Receive Data (TRD0-)	Transmit/Receive Data (TRD1-)
7	Transmit/Receive Data (TRD2+)	Transmit/Receive Data (TRD3+)
8	Transmit/Receive Data (TRD2-)	Transmit/Receive Data (TRD3-)



**Note:**

"+" and "-" indicate level polarities.

- Wiring Sequence

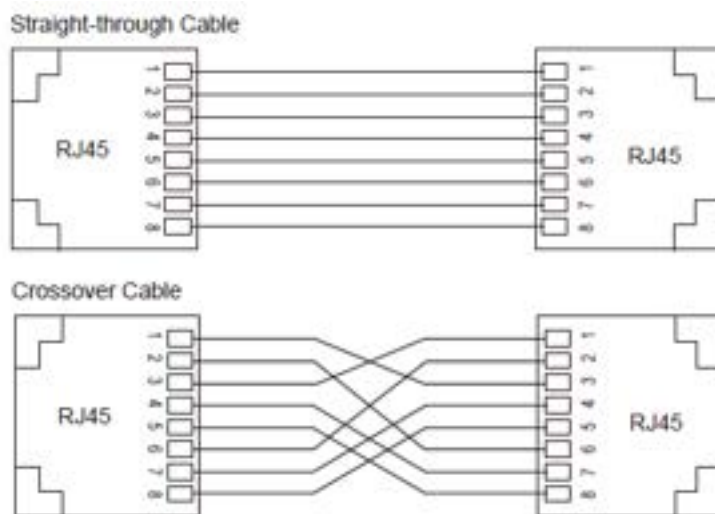

Figure 8 Connection Using Straight-through/Cross-over Cable



**Note:**

The color of the cable for RJ45 connector meets the 568B standard: 1-orange and white, 2-orange, 3-green and white, 4-blue, 5-blue and white, 6-green, 7-brown and white, and 8-brown.

## 4.2 1000Base-X, 10/100/1000Base-T(X) SFP Slot

1000Base-X, 10/100/1000Base-T(X) SFP slot (Gigabit SFP slot): You can enable data transmission only after inserting an SFP optical/electrical module into the slot and connecting cable properly. The following table lists the Gigabit SFP optical/electrical modules (optional) supported by the series switches.

Table 4 Gigabit SFP Optical/Electrical Modules for Gigabit SFP slot

Model	Interface	MM/SM	Connector	Center Wavelength (CWL)	Transmission Distance
IGSFP-M-SX-LC-850-0.55	1000Base-X port	MM	LC	850nm	0.55km
IGSFP-S-LX-LC-1310-10	1000Base-X port	SM	LC	1310nm	10km
IGSFP-S-LH-LC-1310-40	1000Base-X port	SM	LC	1310nm	40km
IGSFP-S-ZX-LC-1550-80	1000Base-X port	SM	LC	1550nm	80km
IG-FSFP-M-LX-LC-1310-2	100Base-FX port	MM	LC	1310nm	2km
IG-FSFP-S-LX-LC-1310-10	100Base-FX port	SM	LC	1310nm	10km
IGSFP-10/100/1000BASE-	10/100/1000Bas	--	RJ45	--	--

T-RJ45	e-T(X) port (self-adaptive)	connector		
--------	--------------------------------	-----------	--	--

### 4.2.1 Gigabit SFP Optical Module

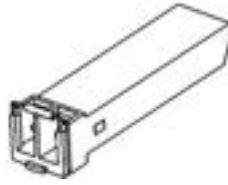

Figure 9 Gigabit SFP Optical Module

Gigabit SFP optical module is equipped with LC connector, and each port consists of a TX (transmit) port and an RX (receive) port. To enable communication between Device A and Device B, connect the TX (transmit) port of Device A to the RX (receive) port of Device B, and the RX (receive) port of Device A to the TX (transmit) port of Device B. The following figure shows the cable connection of the Gigabit SFP optical module.



Figure 10 Cable Connection of Gigabit SFP Optical Module

● How to Connect the SFP Optical Module

Insert the SFP optical module into the SFP slot in the switch, and then plug the optical fiber into the TX port and RX port of the SFP module.

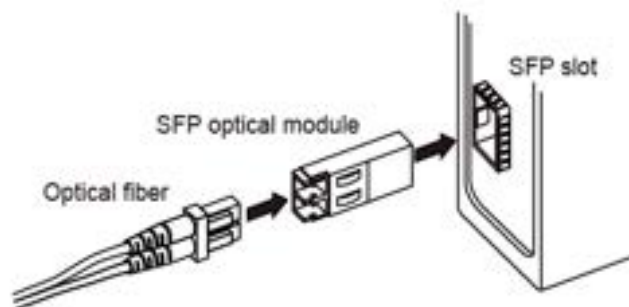

Figure 11 Connecting the Gigabit SFP Optical Module

#### How to Determine the RX Port and TX Port of Gigabit SFP Optical Module

1. Insert the two connectors in one end of optical fiber into the gigabit SFP module, and

those in the other end of the optical fiber into the SFP module of another switch.

2. View the corresponding port connection status LED in the front panel: If the LED blinks, the link is connected. If the LED is off, the link is not connected. This may be caused by incorrect connection of the TX and RX ports. In this case, swap the two connectors in the one end of the optical fiber.



**Caution:**

- The device uses laser to transmit signals in fibers. The laser meets the requirements of level 1 laser products. Routine operation is not harmful to your eyes, but do not look directly at the fiber port when the device is powered on.
- If the defined transmission distance of an SFP module is longer than 60km, do not use a short fiber (<20km) for connection. If such a short fiber is used, the module will be burned.

### 4.2.2 Gigabit SFP Electrical Module



Figure 12 Gigabit SFP Electrical Module

- How to Connect the Gigabit SFP Electrical Module

Insert the SFP electrical module into the SFP slot in the switch, and then plug the RJ45 connector of the twisted pair into the SFP module.

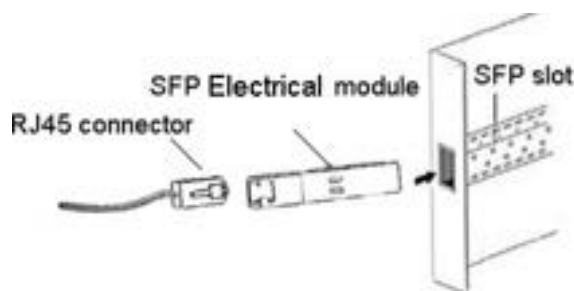

Figure 13 Connecting the Gigabit SFP Electrical Module

### 4.3 1000Base-X, 10/100/1000Base-T(X) Combo port

As shown in following table, the 1000Base-X, 10/100/1000Base-T(X)Combo port

consists of one 1000Base-X port(GX) and one 10/100/1000Base-T(X) Ethernet port, and only one of the two ports can be used at one time, and the 1000Base-X port has priority over 10/100/1000Base-T(X) port. Plug the optical fiber and the twisted pair into GX and GE respectively; GX can communicate normally and the GE will be disabled automatically.

The following table lists the relation of Gigabit SFP ports of Combo port and the corresponding 10/100/1000 Base-T(X) Ethernet port.

Table 5 Combo port corresponding relation

Combo port	1000Base-X SFP port	10/100/1000Base-T(X) Ethernet port
(1)	GX1	GE1
(2)	GX2	GE2
.....	.....	.....

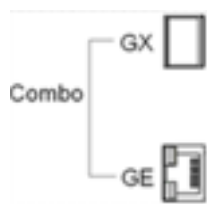

### 4.4 Console Port

There is a Console port on the front panel of the switch, as shown in Figure 14. Connect the 9-pin serial port of a PC to the console port of the switch with a DB9-RJ45 console cable. You can configure, maintain, and manage the switch by running Hyper Terminal in the Windows OS of a computer.

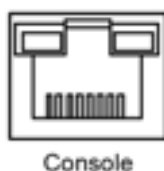

Figure 14 Console Port

- DB9-RJ45 Console Cable

One end of a DB9-RJ45 console cable is the DB9 connector to be inserted into the 9-pin serial port of a PC, and the other end is crimped RJ45 connector to be inserted into the



console port of the switch.

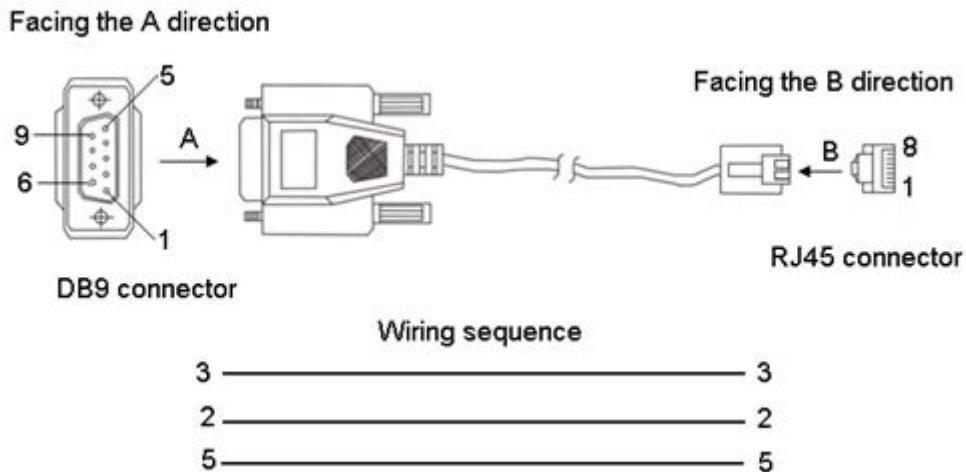

Figure 15 Wiring Sequence of DB9-RJ45 Console Cable

Table 6 Pin Definitions of DB9 Port (9-Pin Serial Port) and RJ45 Port (Console Port)

DB9 Port (9-Pin Serial Port)		RJ45 Port (Console Port)	
Pin	Signal	Pin	Signal
2	RXD (Receive data)	2	TXD (Transmit data)
3	TXD (Transmit data)	3	RXD (Receive data)
5	GND (Grounding)	5	GND (Grounding)

### 4.5 Grounding

Grounding protects the device from lightning and interference. Therefore, you must ground the device properly. You need to ground the device before it is powered on and disconnect the grounding cable after the device is powered off.

There is a grounding screw(see Figure 2) on the top panel of the device. The screw is for chassis grounding. After crimping one end of the grounding cable to a cold pressed terminal, secure the end to the grounding screw and firmly connect the other end to ground.



**Note:**

Cross-sectional area of the chassis grounding cable > 2.5mm<sup>2</sup>; Grounding resistance < 5Ω

### 4.6 Power Terminal Block

There is a power terminal block on the rear panel of the switch. You need to connect the power cable to the terminal block to provide power for the switch.

The device supports single (PWR1) and redundant (PWR1 and PWR2) power supply with a 5-pin 5.08mm-spacing plug-in terminal block. When the redundant power supply is used and one power supply is faulty, the switch can continue operating properly, thereby improving network reliability.



**Note:**

0.75mm<sup>2</sup><Cross-sectional area of the power cable<2.5mm<sup>2</sup>; Grounding resistance: <5Ω

- 5-pin 5.08mm-spacing plug-in terminal block

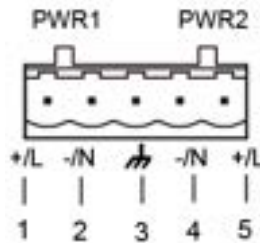

Figure 16 5-Pin 5.08mm-Spacing Plug-in Terminal Block

Table 7 Pin Definitions of 5-Pin 5.08mm-Spacing Plug-in Terminal Block

No.	Signal	DC Definition	AC Definition
1	+/L	PWR1: +	PWR1: L
2	-/N	PWR1: -	PWR1: N
3		PGND	PGND
4	-/N	PWR2: -	PWR2: N
5	+/L	PWR2: +	PWR2: L



**Caution:**

For single power supply, only pins 1, 2, and 3 (PWR1) of the terminal block can be connected. Do not use pins 4 and 5.

- Wiring and mounting

Step 1: Ground the switch properly according to section 4.5.

Step 2: Remove the power terminal block from the switch.

Step 3: Insert the power cable into the power terminal block according to Table 7 to fix the power cable.

Step 4: Insert the terminal with the connected cable into the terminal block on the device.

Step 5: Connect one end of the power cable to an external power supply system (with the allowed power range). If the power LED on the front panel of the switch turns on, the power supply is connected properly.



**Caution:**

Before connecting the device to power supply, make sure that the power input meets the power requirement. If connected to an incorrect power input, the device may be damaged.



**Warning:**

- Do not touch any exposed conducting wire, terminal, or component with a voltage warning sign, because it may cause personal injury.
- Do not remove any part or plug in or out any connector when the device is powered on.

### 4.7 Alarm Terminal Block

The alarm terminal block is used for alarm output. When the switch works properly, the normally-open contacts of the alarm relay are closed and the normally-closed contacts are open. When an alarm occurs, the normally-open contacts are open and the normally-closed contacts are closed. The alarm is outputted through a 3-pin 5.08mm spacing terminal block, as shown in Figure 17.

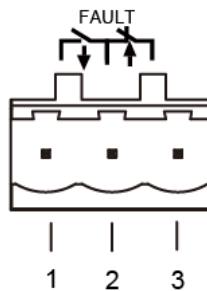

Figure 17 Alarm Terminal Block

Electrical parameters of the relay:

Max Switch Voltage: 250VAC/220VDC

Max Switch Current: 2A

Max Switch Power: 60W

Maximum dielectric voltage withstand: 2KV



**Note:**

Pin 1 and pin 2 are normally-open contacts; pin 2 and pin 3 are normally-closed contacts. When the switch works properly, pin 1 and pin 2 are closed, pin 2 and pin 3 are open; when an alarm occurs, pin 1 and pin 2 are open; pin 2 and pin 3 are closed.

## 5 LEDs

Table 8 Front Panel LEDs

LED		State	Description
Running LED- Run		Blinking	The CPU operates properly.
		On	The device is starting up.
		Off	The device does not start up.
Alarm LED- Alarm		On	An alarm occurs.
		Off	No alarm occurs.
Power 1 LED- PWR1		On	Power 1 is connected and operates properly.
		Off	Power 1 is not connected or operates abnormally.
Power 2 LED- PWR2		On	Power 2 is connected and operates properly.
		Off	Power 2 is not connected or operates abnormally.
Port speed LEDs- Speed (1-24)	SFP optical module	On	1000M working state (1000Base-X)
		Off	100M working state (100Base-FX) or no connection
	SFP electrical module	On	1000M working state (1000Base-TX)
		Off	10/100M working state (10/100Base-T(X)) or no connection
Connection status LEDs-Link/ACT (1-24)		On	Effective port connection
		Blinking	Ongoing network activities
		Off	No effective port connection

Table 9 Rear Panel LEDs

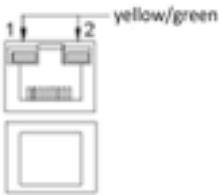
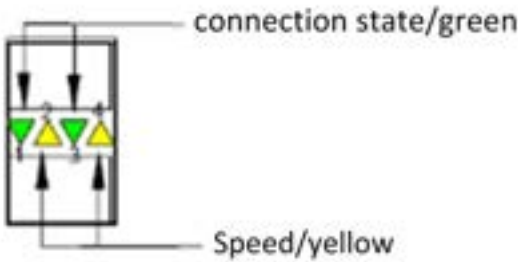
LED	State	Description	
<div style="text-align: center;">  </div> <p>LED 1 indicate the status of the lower slot, while LED 2 indicate the status of the upper slot.</p>			
10/100/1000Base-T(X) Ethernet port speed LED (yellow)	On	Effective port connection and 1000M working state (1000Base-T)	
	Blinking	Ongoing network activities and 1000M working state	
	Off	No effective port connection	
10/100Base-T(X) Ethernet port connection status LED (green)	On	Effective port connection and 10/100M working state (10/100Base-T(X))	
	Blinking	Ongoing network activities and 10/100M working state	
	Off	No effective port connection	
<div style="text-align: center;">  </div> <p>LED 1 and LED 2 indicate the status of the lower gigabit SFP slot, while LED 3 and LED 4 indicate the status of the upper gigabit SFP slot.</p>			
Gigabit SFP Slot and 100Base-FX port connection status LED	Gigabit SFP Optical Module	On	1000M working state(1000Base-X)
		Off	100M working state(100Base-FX) or no connection
	Gigabit SFP Electrical Module	On	1000M working state(1000Base-TX)
		Off	10/100M working state(10/100Base-T(X)) or

			no connection
1000Base-X,10/100/1000Base-T(X) port connection status LED	SFP	On	Effective port connection
		Blinking	Ongoing network activities
		Off	No effective port connection

## 6 Switch Access

You can access the switch in any of the following ways:

### 6.1 Access through Console Port

Step 1: Connect the console port of the switch to the 9-pin serial port of a PC with the delivered DB9-RJ45 console cable.

Step 2: Open the Hyper Terminal in the Windows OS. On the desktop, click Start → All Programs → Accessories → Communications → Hyper Terminal.

Step 3: Create a connection "Switch", as shown in Figure 18.



Figure 18 Creating a Connection

Step 4: Connect the communication port in use, as shown in Figure 19.



Figure 19 Selecting the Communication Port in Use



**Note:**

To confirm the communication port in use, right-click [My Computer] and click [Property]→ [Hardware]→[Device Manager]→[Port] to view the communication port.

Step 5: Set port parameters (Bits per second: 9600, Data bits: 8, Parity: None, Stop bits: 1, and Flow control: None), as shown in Figure 20.



Figure 20 Setting Port Parameters

Step 6: Click OK to enter the switch CLI. Then you can run the following commands to



perform operations.

Table 10 CLI Commands

View	Command	Description
User view	SWITCH>enable	Enter the management view.
Management view	SWITCH#show interface	Query the IP address of the switch.
Management view	SWITCH#show version	Query the version of the switch.
Management view	SWITCH#reboot	Restart the switch.
Management view	SWITCH#load default	Restore the factory default settings
Management view	SWITCH#config terminal	Enter the configuration view.

## 6.2 Access through Telnet

Step 1: Connect the network port of a PC to the Ethernet port of the switch with a network cable.

Step 2: Enter "telnet IP-address" in the Run dialog box, as shown in Figure 21. The default IP address of a Kyland switch is 192.168.0.2.

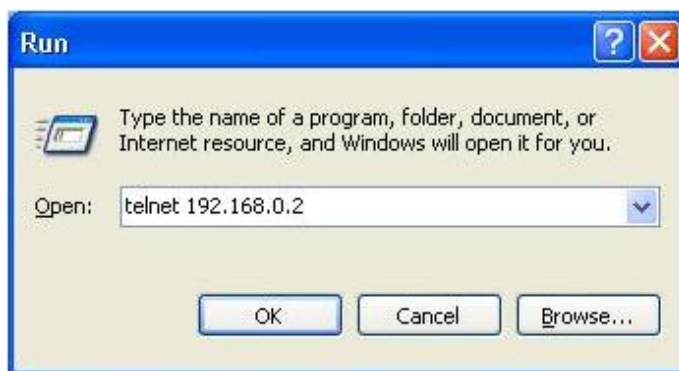

Figure 21 Access through Telnet

Step 3: Click OK. The Telnet CLI is displayed. Then you can enter commands (as shown in Table 10) to perform operations.

## 6.3 Access through Web

Step 1: Connect the network port of a PC to the Ethernet port of the switch with a network cable.

Step 2: Enter the IP address of the switch in the address box of the browser. The user login interface is displayed. You can log in to the Web UI by default user name "admin" and password "123".

---

**Note:**

- IE8.0 or a later version is recommended..
  - For details about how to access the switch and other operation, refer to the Web operation manual in the delivered CD.
-

## 7 Basic Features and Specifications

### Power Requirements

Power Identifier	Rated Voltage Range	Maximum Voltage Range
HV (220AC/DCW)	100-240VAC, 50/60Hz; 110-220VDC	85-264VAC/77-300VDC
Power terminal	5-pin 5.08mm-spacing plug-in terminal block	

### Rated Power Consumption

Rated Power Consumption	42W (MAX)
-------------------------	-----------

### Physical Characteristics

Housing	Metal, fanless
Installation	19-inch 1U rack mounting
Dimensions (W×H×D)	440mm×44mm×325mm (excluding the connector and mounting brackets)
Weight	6.16Kg (excluding package and accessories)

### Environmental Limits

Operating temperature	-20°C ~ +60°C
Storage temperature	-40°C to +85°C
Ambient relative humidity	5% to 95% (non-condensing)

### MTBF

MTBF	346,889 hours
------	---------------

### Warranty

Warranty	5 years
----------	---------

***KYLAND***

FAX: +86-10-88796678

Website: <http://www.kyland.com>

Email: [support@kyland.com](mailto:support@kyland.com)

For more information about KYLAND  
products, please visit our website:

<http://www.kyland.com>