

SICOM3028GPT Series Industrial Ethernet Switches Hardware Installation Manual

Publication Data: Sep. 2016

Version: V1.3

KYLAND

SICOM3028GPT Series Industrial Ethernet Switches

Hardware Installation Manual

Disclaimer: Kyland Technology Co., Ltd. tries to keep the content of this manual as accurate and as updated as possible. This document is not guaranteed to be error-free, and we reserve the right to amend it without notice to users.

All rights reserved.

No part of this documentation may be excerpted, reproduced, translated, annotated or duplicated, in any form or by any means without the prior written permission of KYLAND Corporation.

Copyright © 2016 Kyland Technology Co., Ltd.

Notice for Safety Operation

The product performs reliably as long as it is used according to the guidance. Artificial damage or destruction of the device should be avoided. Before using the device, read this manual carefully for personal and equipment safety. Please keep the manual for further reference. Kyland is not liable to any personal or equipment damage caused by violation of this notice.

- Do not place the device near water sources or damp areas. Keep the ambient relative humidity within the range from 5% to 95% (non-condensing).
- Do not place the device in an environment with high magnetic field, strong shock, or high temperature. Keep the working and storage temperatures within the allowed range.
- Install and place the device securely and firmly.
- Please keep the device clean; if necessary, wipe it with a soft cotton cloth.
- Do not place any irrelevant materials on the device or cables. Ensure adequate heat dissipation and tidy cable layout without knots.
- Wear antistatic gloves or take other protective measures when operating the device.
- Avoid any exposed metal wires because they may be oxidized or electrified.
- Install the device in accordance with related national and local regulations.
- Before power-on, make sure the power supply is within the allowed range of the device. High voltage may damage the device.
- Power connectors and other connectors should be firmly interconnected.
- Do not plug in or out the power supply with wet hands. When the device is powered on, do not touch the device or any parts with wet hands.
- Before operating a device connected to a power cable, remove all jewelry (such as rings, bracelets, watches, and necklaces) or any other metal objects, because they may cause electric shock or burns.
- Do not operate the device or connect or disconnect cables during an electrical storm.
- Use compatible connectors and cables. If you are not sure, contact our sales or technical support personnel for confirmation.

- Do not disassemble the device by yourself. When an anomaly occurs, contact our sales or technical support personnel.
- If any part is lost, contact our sales or technical support personnel to purchase the substitute. Do not purchase parts from other channels.
- Dispose of the device in accordance with relevant national provisions, preventing environmental pollution.
- Specification of the internal fuses in this equipment: 3.15A/300V.

In the following cases, please immediately shut down your power supply and contact your Kyland representative:

- Water gets into the equipment.
- Equipment damage or shell damage.
- Equipment operation or performance has abnormally changed.
- The equipment emits odor, smoke or abnormal noise.

The following information applies when operating this device in hazardous locations:

Suitable for use in Class I, Division 2, Groups A, B, C and D Hazardous Locations, or nonhazardous locations only.

Cet appareillage est utilisable dans les emplacements de Classe I, Division 2, Groupes A, B, C et D, ou dans les emplacements non dangereux seulement.

WARNING: EXPLOSION HAZARD

- Do not disconnect equipment while the circuit is live or unless the area is known to be free of ignitable concentrations.
- Substitution of any component may impair suitability for Class I, Division 2.

AVERTISSEMENT: RISQUE D'EXPLOSION

- Avant de deconnecter l'equipement, couper le courant ou s'assurer que l'emplacement est designe non dangereux.
- La substitution de composants peut rendre ce materiel inacceptable pour les emplacements de Classe I, Division 2.

Contents

1 Product Overview	1
2 Structure and Interface	5
2.1 Front Panel	5
2.2 Rear Panel	6
2.2.1 1U Interface Module	6
2.2.2 0.5U Interface Module	7
3 Interface Module Installation	8
3.1 Mounting Modes and Steps	8
3.1.1 Installing Mounting Brackets.....	9
3.1.2 Inserting a 0.5U Interface Module into an Upper Slot (Slot 2, Slot 4, or Slot 6)	9
3.1.3 Inserting a 0.5U Interface Module into a Lower Slot (Slot 3, Slot 5, or Slot 7)	10
3.1.4 Inserting a 1U Interface Module into Slot 1	12
3.2 Dismounting	12
3.2.1 Removing a 0.5U Interface Module	12
3.2.2 Removing a 1U Interface Module	12
4 Switch Installation.....	14
4.1 Dimension Drawing	14
4.2 Mounting Modes and Steps	15
5 Connection	18
5.1 10/100Base-T(X) Ethernet Port.....	18
5.2 100Base-FX Ethernet Port.....	19
5.3 10/100/1000Base-T(X) Ethernet Port.....	20
5.4 1000Base-X, 10/100/1000Base-T(X) SFP slot.....	21
5.4.1 Gigabit SFP Optical Module	22
5.4.2 Gigabit SFP Electrical Module	23
5.5 Console Port	23
5.6 Grounding	25

5.7 Power Terminal Block	26
5.8 Alarm Terminal Block	28
6 LEDs	30
7 Switch Access	33
7.1 Access through Console Port.....	33
7.2 Access through Telnet	35
7.3 Access through Web	36
8 Basic Features and Specifications.....	37

1 Product Overview

The series switches include layer-2 switches and layer-3 switches. With modular design, all these switches support IRIG-B, GPS, serial port, HSR, and many other modules for easy expansion.

Based on the full gigabit switching platform, the series switches are the first industrial Ethernet switches that employ the IEC61850 modeling technology in the world, achieving unified management. The switches support IEC62439-6 and IEC62439-3 ring redundancy protocol and comply with the IEC61850-3 and IEEE1613 power industry standards. With industry-leading clock frequency synthesis technology, the switches support IEEE1588-2008 Precision Time Protocol (PTP), as listed in Table 1. All these features enable the switches to well suit the Smart Grid industry.

The series switches support 19 inch 1U rack mounting by front/rear panel. They provide two console ports on the front panel and one 1U and six 0.5U slots for interface modules on the rear panel.

Table 1 Models

Model	SICOM3028GPT-L2GT-MB-PS1-PS2, SICOM3028GPT-L2FT-MB-PS1-PS2, SICOM3028GPT-L2G-MB-PS1-PS2, SICOM3028GPT-L2F-MB-PS1-PS2, SICOM3028GPT-L3GT-MB-PS1-PS2, SICOM3028GPT-L3FT-MB-PS1-PS2, SICOM3028GPT-L3G-MB-PS1-PS2, SICOM3028GPT-L3F-MB-PS1-PS2
Code definition	Code option
L2GT-MB	Layer 2 1000M IEEE1588-compliant host
L2FT-MB	Layer 2 100M IEEE1588-compliant host
L2G-MB	Layer 2 1000M IEEE1588 non-compliant host
L2F-MB	Layer 2 100M IEEE1588 non-compliant host
L3GT-MB	Layer 3 1000M IEEE1588-compliant host
L3FT-MB	Layer 3 100M IEEE1588-compliant host
L3G-MB	Layer 3 1000M IEEE1588 non-compliant host

L3F-MB	Layer 3 100M IEEE1588 non-compliant host
PS1: power input 1	HV(220AC/DCW), L1(48DC), L3(24DC)
PS2: power input 2	HV(220AC/DCW), L1(48DC), L3(24DC), N/A

Table 2 Interface Modules (1U)

Model	SM6.6-Ports-1U
Code definition	Code option
Ports: GX/GE	4GX, 4GE, 2GX2GE
	<p>Note:</p> <p><i>2GX2GE: two 1000Base-X, 10/100/1000Base-T(X) SFP slots; two 10/100/1000Base-T(X) ports</i></p>

Table 3 Interface Modules (0.5U)

Model	SM6.6-Ports-Connector-0.5U
Code definition	Code option
Ports: GX/GE, S/M, T	<p>SICOM3028GPT-L2GT-MB, SICOM3028GPT-L2G-MB,</p> <p>SICOM3028GPT-L3GT-MB, SICOM3028GPT-L3G-MB:</p> <p>4GE, 4GX, 2GX2GE, 2GX2S, 2GX2M</p> <p>All SICOM3028GPT models:</p> <p>4S, 4M, 2S2T, 2M2T, 4T</p>
	<p>Note:</p> <p><i>2GX2GE: two 1000Base-X, 10/100/1000Base-T(X) SFP slots; two 10/100/1000Base-T(X) ports</i></p> <p><i>2S2T: two 100Base-FX ports, single mode; two 10/100Base-T(X) ports</i></p> <p><i>2M2T: two 100Base-FX ports, multiple mode; two 10/100Base-T(X) ports</i></p>
Connector: parameters for S/M	<p>Ports with M:</p> <p>SC05=SC connector, 1310nm, 5km</p> <p>ST05=ST connector, 1310nm, 5km</p>

	<p>FC05=FC connector, 1310nm, 5km</p> <p>Ports with S:</p> <p>SC40=SC connector, 1310nm, 40km</p> <p>ST40=ST connector, 1310nm, 40km</p> <p>FC40=FC connector, 1310nm, 40km</p> <p>SC60=SC connector, 1310nm, 60km</p> <p>SC80=SC connector, 1550nm, 80km</p> <p>Ports without S or M:</p> <p>N/A</p>
--	---

Table 4 Other Modules

Model	Description	Applicable to
SM6.6-GPS-OI-0.5U	GPS-to-PTP clock synchronization module, supports one GPS input, and one PPS output	SICOM3028GPT-L2GT-MB, SICOM3028GPT-L2FT-MB, SICOM3028GPT-L3GT-MB, SICOM3028GPT-L3FT-MB
SM6.6-GPS-OI-FI-0.5U	GPS-to-PTP clock synchronization module, supports one GPS input, one 5M/10M frequency input, and one PPS output	
SM6.6-PTP-BO-0.5U	PTP-to-IRIG-B clock conversion module, supports two IRIG-B (DC) outputs, two IRIG-B (AC) outputs, one PPS output	
SM6.6-PTP-over-E1-0.5U	PTP over E1 clock synchronization module, supports E1 interface with balanced connection	
SM6.6-4D-232/422/485-0.5U	Serial port module without RTS Carrier Control, supports four RS232/RS422/RS485 serial ports	All SICOM3028GPT models
SM6.6-4D-A-4RS232/422/485-0.5U	Serial port module with RTS Carrier Control, supports four RS232/RS422/RS485 serial ports	
SM6.6-HSR/PRP-GX-0.5U	HSR/PRP Redbox module, supports two 1000Base-X, 10/100/1000Base-T(X) SFP slots	SICOM3028GPT-L2GT-MB, SICOM3028GPT-L2G-MB,

SM6.6-HSR/PRP-GE-0.5U	HSR/PRP Redbox module, supports two 10/100/1000Base-T(X) ports	SICOM3028GPT-L3GT-MB, SICOM3028GPT-L3G-MB
SM6.6-MFA-0.5U	Multi functional application module, supports one 1000Base-X, 10/100/1000Base-T(X) Combo port	



Note:

For the product information listed in these tables, we reserve the right to amend it without notice.

To obtain the latest information, you can contact our sales or technical support personnel.

2 Structure and Interface



Caution:

It is recommended to purchase the port dustproof shield (optional) to keep ports clean and ensure device performance.

2.1 Front Panel

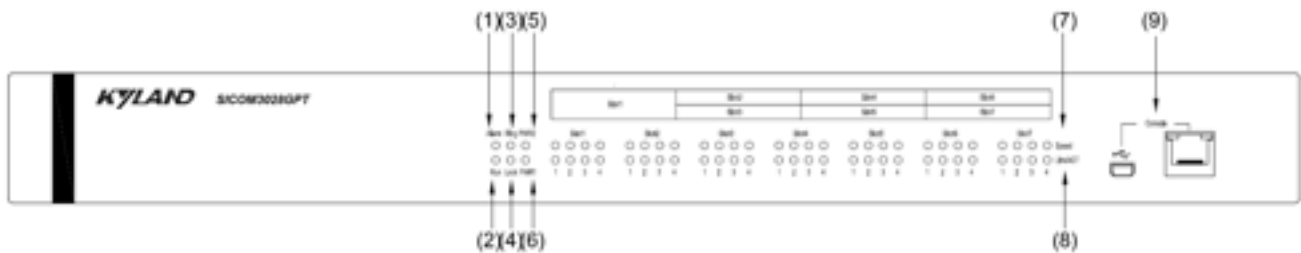

Figure 1 Front Panel

Table 5 Description of the Front Panel

No.	Identifier	Description
(1)	Alarm	Alarm LED
(2)	Run	Running LED
(3)	Ring	Ring LED
(4)	Lock	Synchronization Finish LED
(5)	PWR2	Power 2 LED
(6)	PWR1	Power 1 LED
(7)	Slot (1-7) Speed (1-4)	Four port speed LEDs (for interface module slots 1 to 7)
(8)	Slot (1-7) Link/ACT (1-4)	Four port connection status LEDs (for interface module slots 1 to 7)
(9)	Console	Two console ports

2.2 Rear Panel

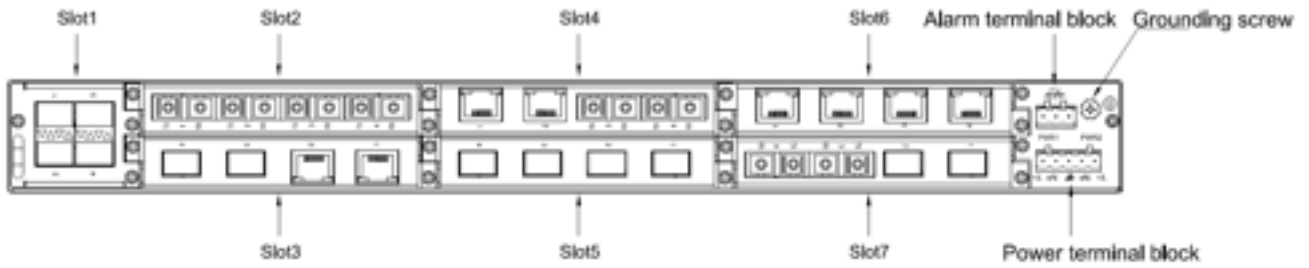

Figure 2 Rear Panel

2.2.1 1U Interface Module

- SM6.6-4GX-1U



1-4: four 1000Base-X, 10/100/1000Base-T(X) SFP slots

- SM6.6-2GX2GE-1U



1-2: two 10/100/1000Base-T(X) Ethernet ports

3-4: two 1000Base-X, 10/100/1000Base-T(X) SFP slots

- SM6.6-4GE-1U

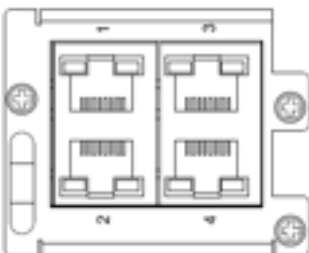

1-4: four 10/100/1000Base-T(X) Ethernet ports

2.2.2 0.5U Interface Module

- SM6.6-4GX-0.5U

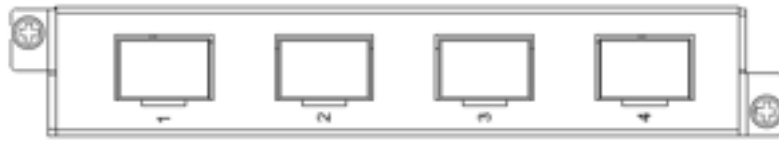

1-4: four 1000Base-X, 10/100/1000Base-T(X) SFP slots

- SM6.6-2GX2M-SC05-0.5U, SM6.6-2GX2S-SC40-0.5U



1-2: two 100Base-FX Ethernet ports (FC/ST/SC connector)

3-4: two 1000Base-X, 10/100/1000Base-T(X) SFP slots

- SM6.6-4GE-0.5U

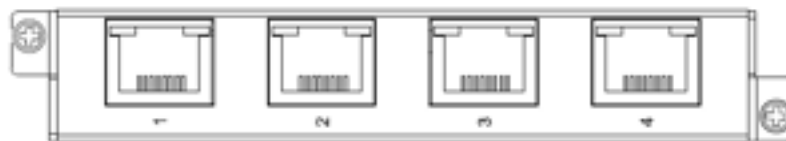

1-4: four 10/100/1000Base-T(X) Ethernet ports

(Note: Its appearance is identical with that of SM6.6-4T-0.5U. You can distinguish them by labels on the front panel.)

- SM6.6-2GX2GE-0.5U

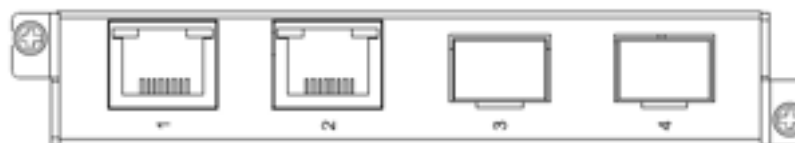

1-2: two 10/100/1000Base-T(X) Ethernet ports

3-4: two 1000Base-X, 10/100/1000Base-T(X) SFP slots

- SM6.6-4M-SC05-0.5U, SM6.6-4S-SC40-0.5U



1-4: four 100Base-FX Ethernet ports (FC/ST/SC connector)

- SM6.6-2M2T-SC05-0.5U, SM6.6-2S2T-SC40-0.5U

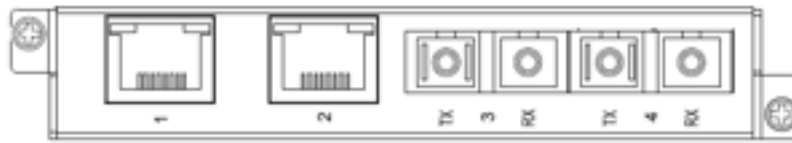

1-2: two 10/100Base-T(X) Ethernet ports

3-4: two 100Base-FX Ethernet ports (FC/ST/SC connector)

- SM6.6-4T-0.5U



1-4: four 10/100Base-T(X) Ethernet ports

(**Note:** Its appearance is identical with that of SM6.6-4GE-0.5U. You can distinguish them by labels on the front panel.)

- SM6.6-GPS-OI-0.5U

For details, refer to the *GPS Clock Synchronization Module Hardware Installation Manual*.

- SM6.6-PTP-BO-0.5U

For details, refer to the *IRIG-B Clock Conversion Module Hardware Installation Manual*.

- SM6.6-4D-232/422/485-0.5U, SM6.6-4D-A-4RS232/422/485-0.5U

For details, refer to the *Serial Device Server Module Hardware Installation Manual*.

- SM6.6-HSR/PRP-GX-0.5U, SM6.6-HSR/PRP-GE-0.5U

For details, refer to the *HSP/PRP Redbox Module Hardware Installation Manual*.

3 Interface Module Installation



Caution:

Power off the switch before you install or remove an interface module.

3.1 Mounting Modes and Steps

The series switches provide one 1U slot (Slot 1) and six 0.5U slots (Slot 2-Slot 7) on the rear panel, as shown in Figure 2. You can install interface modules as needed. Table 2- Table 4

list the models of the interface modules.



Note:

Not all the slots require interface modules. Choose slots as needed.

3.1.1 Installing Mounting Brackets

Before inserting a 0.5U interface module into an upper or lower slot, install mounting brackets on the module as follows:

Select an applicable 0.5U interface module. Insert two mounting brackets into the screw holes at both sides of the module. Push the brackets in direction 1 until the brackets are firmly secured to the module.

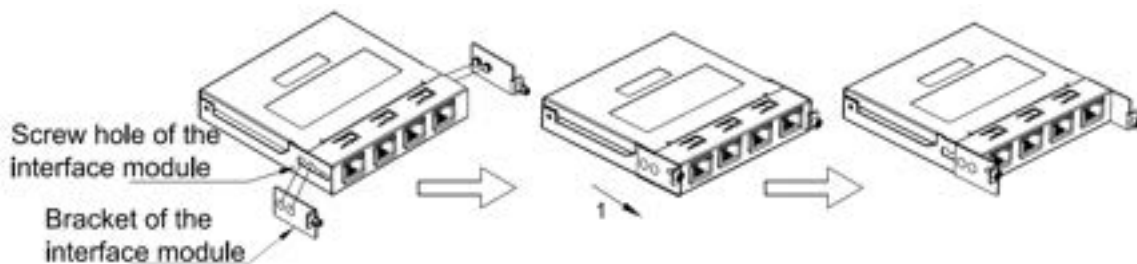

Figure 3 Installing Mounting Brackets

3.1.2 Inserting a 0.5U Interface Module into an Upper Slot (Slot 2, Slot 4, or Slot 6)

Step 1: Insert the guide rail of the interface module into the guide rail slot with "TOP" facing up. Then push the module into the slot along the guide rail slot until it is in position.

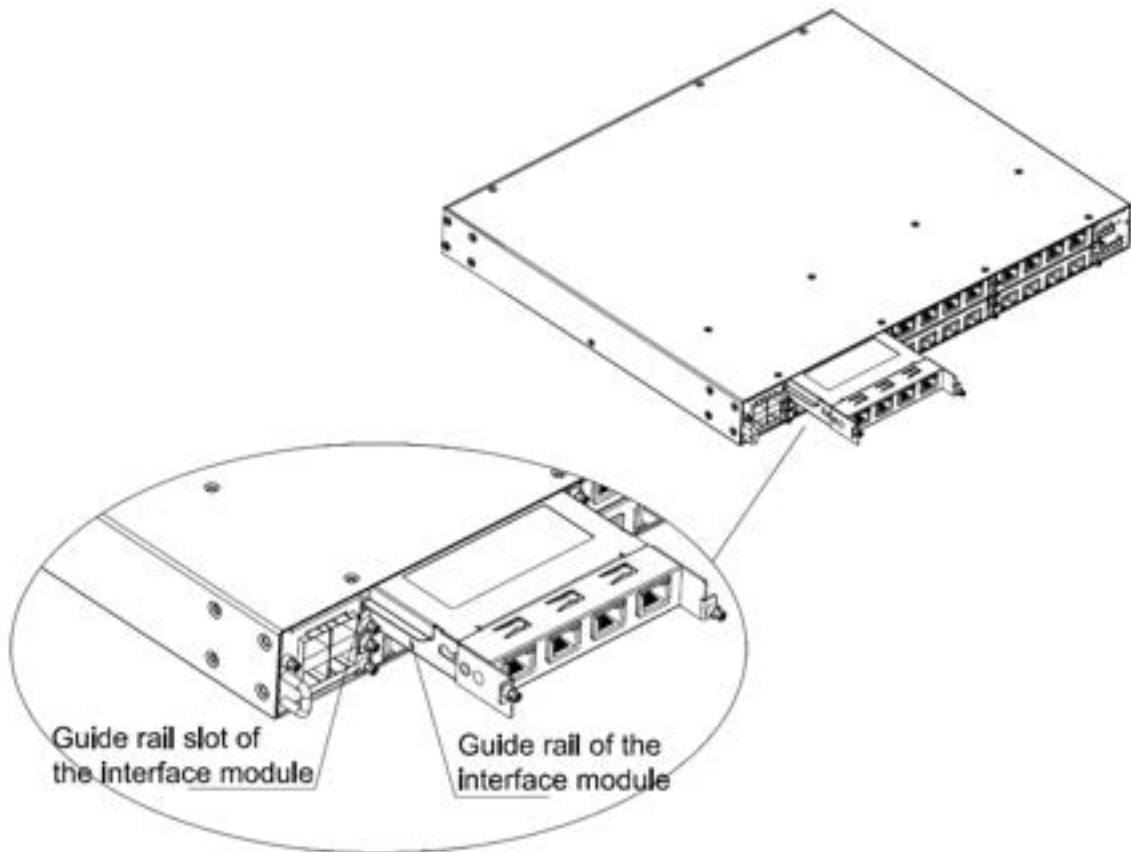

Figure 4 Inserting a 0.5U Interface Module into an Upper Slot



Caution:

- To insert an interface module into an upper slot, keep the "TOP" identifier on the module facing up.
- If the module cannot be pushed into place, do not force it, because too much force may cause damage to the module. In this case, remove the module and check the guide rail slot for any foreign materials or deformation. If the fault cannot be rectified, contact our sales or technical support personnel

Step 2: Push the mounting brackets into the slot completely. Insert two captive screws (M2.5×6) into the screw holes of the switch to secure the interface module to the switch.

3.1.3 Inserting a 0.5U Interface Module into a Lower Slot (Slot 3, Slot 5, or Slot 7)

Step 1: Insert the guide rail of the interface module into the guide rail slot with "TOP" facing

down. Then push the module into the slot along the guide rail slot until it is in position.

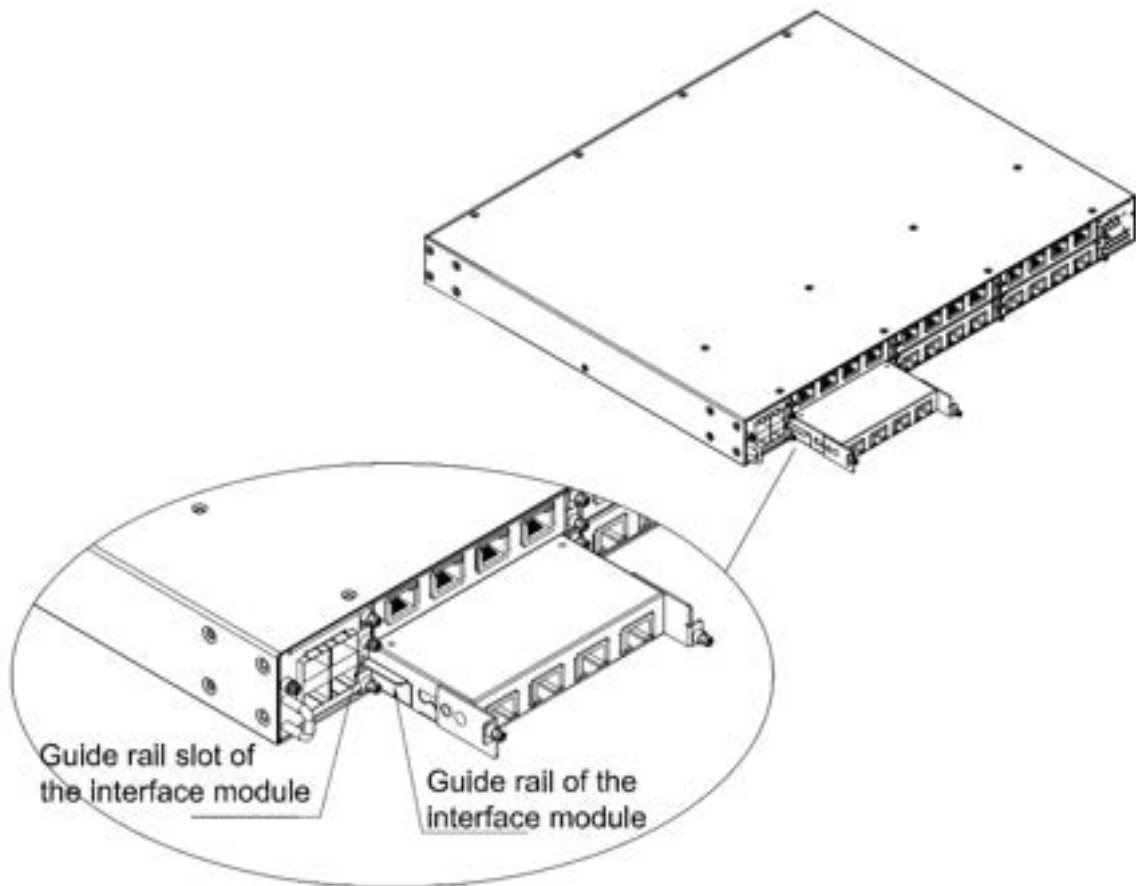

Figure 5 Inserting a 0.5U Interface Module into a Lower Slot



Caution:

- To insert an interface module into a lower slot, keep the "TOP" identifier on the module facing down.
- If the module cannot be pushed into place, do not force it, because too much force may cause damage to the module. In this case, remove the module and check the guide rail slot for any foreign materials or deformation. If the fault cannot be rectified, contact our sales or technical support personnel.

Step 2: Push the mounting brackets into the slot completely. Insert two captive screws (M2.5×6) into the screw holes of the switch to secure the interface module to the switch.

3.1.4 Inserting a 1U Interface Module into Slot 1

The steps for inserting a 1U interface module into Slot 1 is the same as those for inserting a 0.5U interface module into an upper slot (Slot 2, Slot 4, or Slot 6). For details, see section 3.1.2.

3.2 Dismounting

3.2.1 Removing a 0.5U Interface Module

The steps for removing an interface module from an upper slot and a lower slot are the same.

Detailed steps are as follows:

Step 1: Remove the two screws securing the module to the switch.

Step 2: Pull out the mounting brackets.

Step 3: Remove the module from the switch by holding the brackets.

Step 4: Remove the brackets from the module, as shown in the following figure.

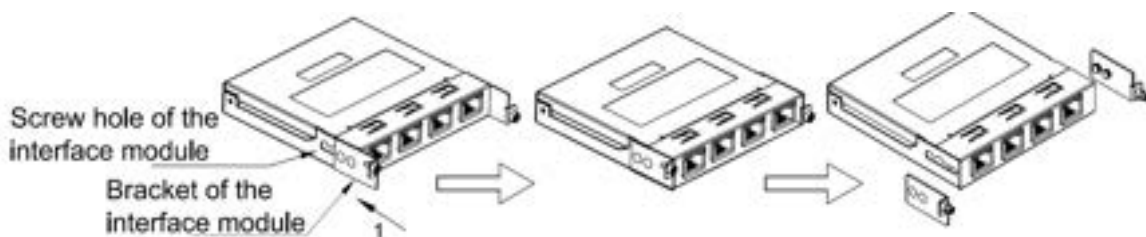

Figure 6 Removing Mounting Brackets

3.2.2 Removing a 1U Interface Module

Step 1: Remove the three screws (M2.5×6) securing the module to the switch.

Step 2: Pull out the module by holding the handle until the module is completely detached from the slot.

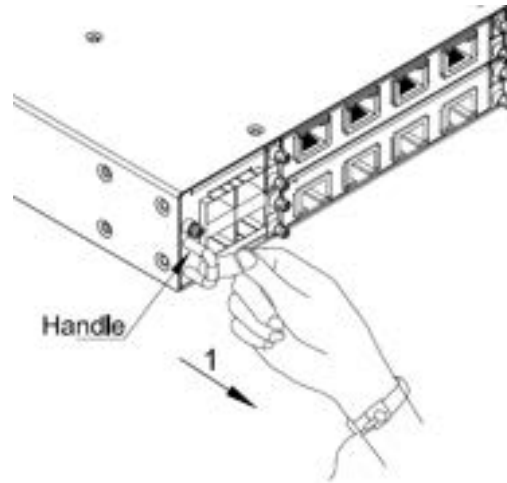

Figure 7 Removing a 1U Interface Module

4 Switch Installation

4.1 Dimension Drawing

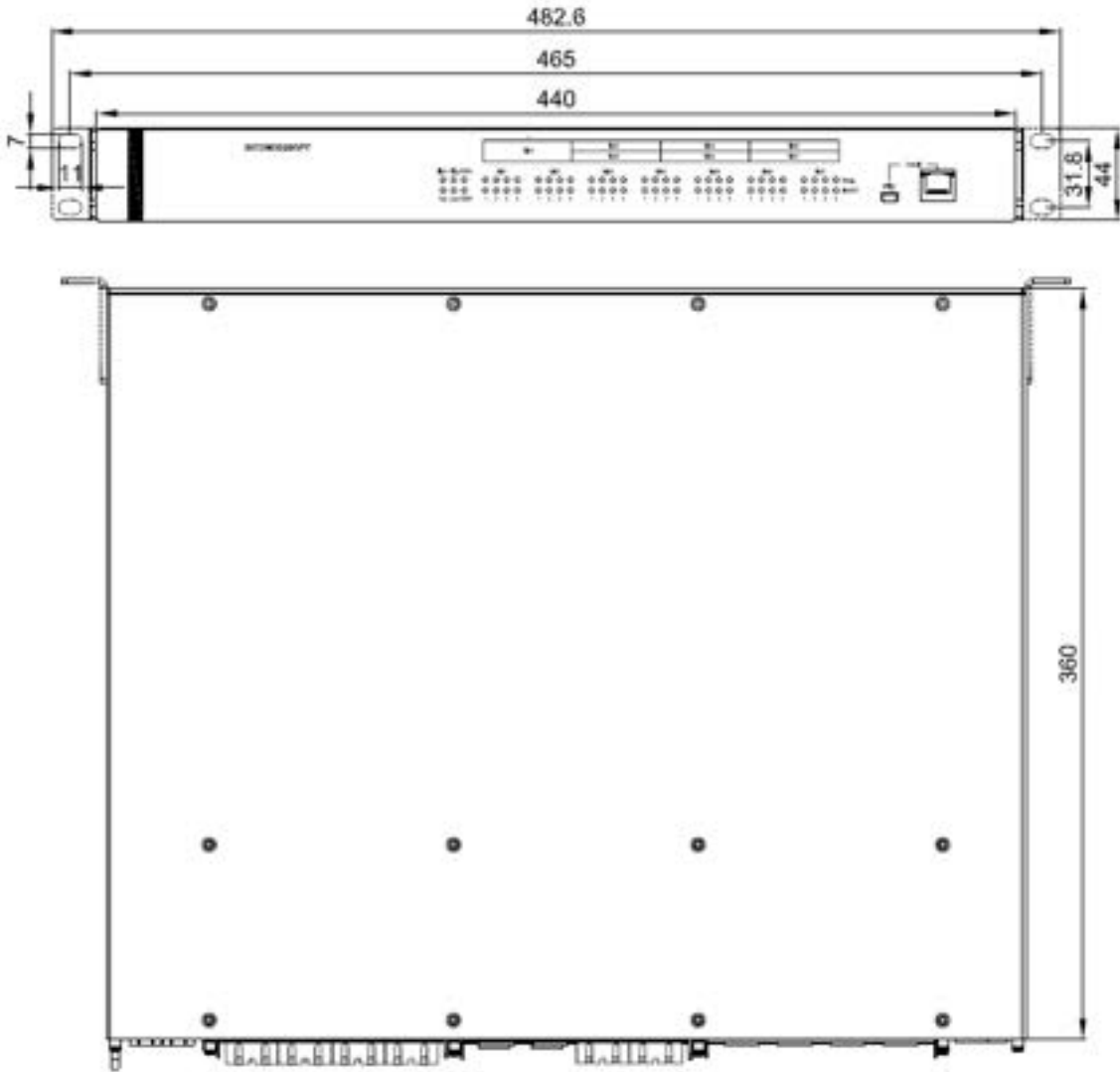

Figure 8 Dimensions (unit: mm)



Caution:

- As part of the heat dissipation system, the switch housing becomes hot during operation. Please use caution when coming in contact and avoid covering the switch housing when the switch is running.
- The figures in this manual are only for reference.

4.2 Mounting Modes and Steps

The series switches support rack mounting by front/rear panel. The following uses mounting by front panel as an example to describe mounting steps. The steps for mounting by rear panel are similar to those for mounting by front panel. Before installation, make sure that the following requirements are met.

- 1) Environment: temperature (-40°C to 85°C), ambient relative humidity (5% to 95%, non-condensing)
- 2) Power requirement: The power input is within the voltage range of the switch.
- 3) Grounding resistance: <math><5\Omega</math>
- 4) No direct sunlight, distant from heat source and areas with strong electromagnetic interference.
- 5) Devices are to be installed in an authority certified enclosure and accessible only by the use of a tool.
- 6) Devices should be installed and accessed by service personnel or users who have been instructed about the reasons for the restrictions applied to the location and about any precautions that shall be taken.

- Installing Mounting Brackets

The mounting brackets for this series switches support two mounting positions, as indicated by the two dashed boxes in the following figure. You can select either of the mounting positions as needed.

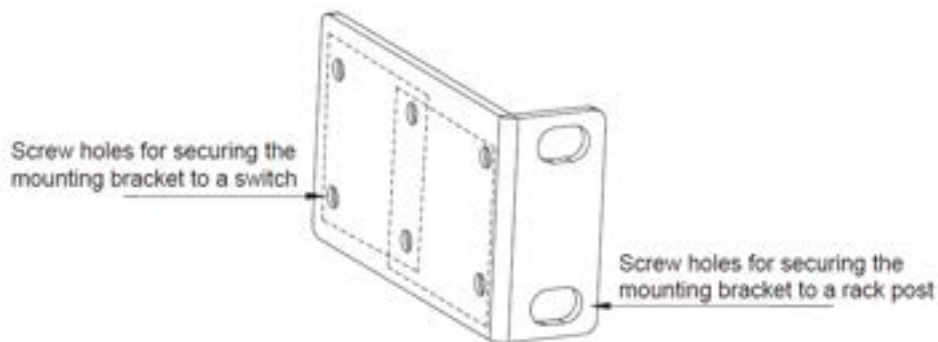

Figure 9 Mounting Bracket

You can select the screw holes for front or rear panel mounting to install the mounting

brackets. If there are screws inserted in the screw holes, remove the screws and keep them for future use.

As shown in the following figure, use four screws to secure two mounting brackets to the switch respectively.

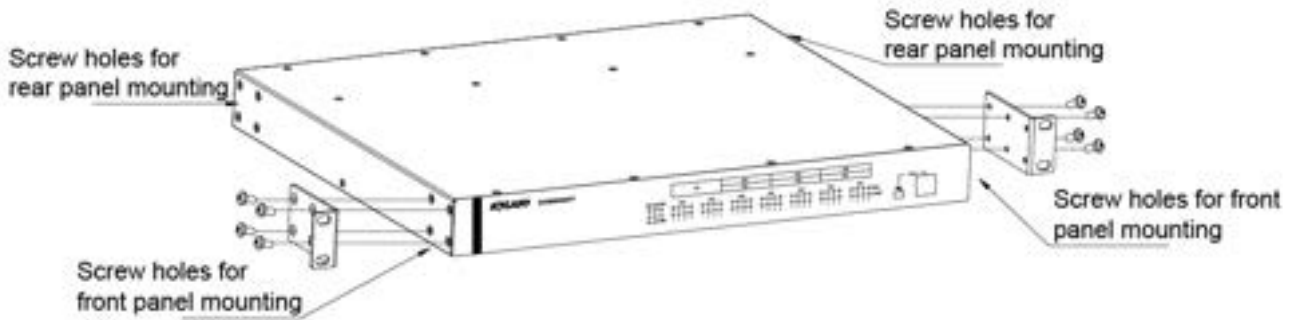

Figure 10 Installing Mounting Brackets

- Mounting

Step 1: Select the mounting position for the switch and guarantee adequate space and heat dissipation (house dimensions: 440mm×44mm×360mm).

Step 2: Move the switch in direction 1 until the screw holes for securing the mounting brackets to rack posts are in alignment with the corresponding holes in the rack posts. Then use four screws and supporting captive nuts to secure the mounting brackets to the rack posts.

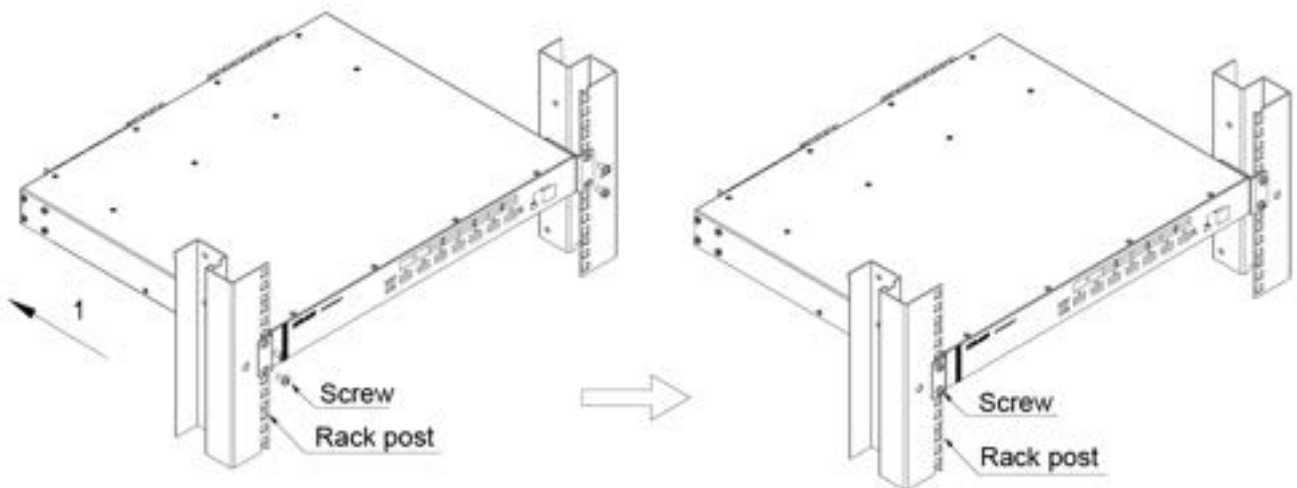

Figure 11 Mounting

- Dismounting

Step 1: Remove the four screws and supporting captive nuts securing the mounting brackets

to the rack posts.

Step 2: Remove the switch from the rack posts. Then unscrew the mounting brackets to complete dismounting.

**Caution:**

Cut off the power and disconnect all cables before mounting, dismounting or moving the equipment.

5 Connection

5.1 10/100Base-T(X) Ethernet Port

10/100Base-T(X) Ethernet port is equipped with RJ45 connector. The port is self-adaptive. It can automatically configure itself to work in 10M or 100M state, full or half duplex mode. The port can also adapt to MDI or MDI-X connection automatically. You can connect the port to a terminal or network device with a straight-through or cross-over cable.

- Pin Definition

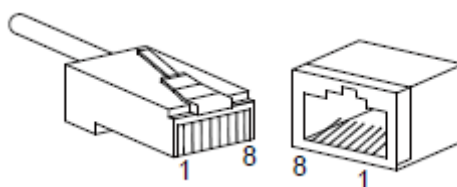



Figure 12 RJ45 Port

Table 6 Pin Definitions of 10/100Base-T(X) Ethernet Port

Pin	MDI-X Signal	MDI Signal
1	Receive Data+ (RD+)	Transmit Data+ (TD+)
2	Receive Data- (RD-)	Transmit Data- (TD-)
3	Transmit Data+ (TD+)	Receive Data+ (RD+)
6	Transmit Data- (TD-)	Receive Data- (RD-)
4, 5, 7, 8	Unused	Unused
 Note: "+" and "-" indicate level polarities.		

- Wiring Sequence

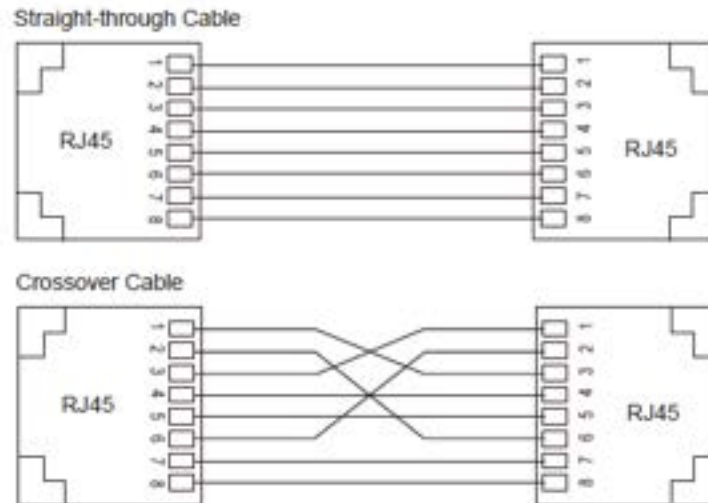

Figure 13 Connection Using Straight-through/Cross-over Cable



Note:

The color of the cable for RJ45 connector meets the 568B standard: 1-orange and white, 2-orange, 3-green and white, 4-blue, 5-blue and white, 6-green, 7-brown and white, and 8-brown.

5.2 100Base-FX Ethernet Port

100Base-FX Ethernet port is equipped with FC/ST/SC connector, and each port consists of TX (transmit) port and RX (receive) port. To enable data transmission between Device A and Device B, connect the TX port of Device A to the RX port of Device B, and the RX port of Device A to the TX port of Device B. The following uses an SC port as an example. The wiring sequence of an ST/FC port is the same with that of the SC port.

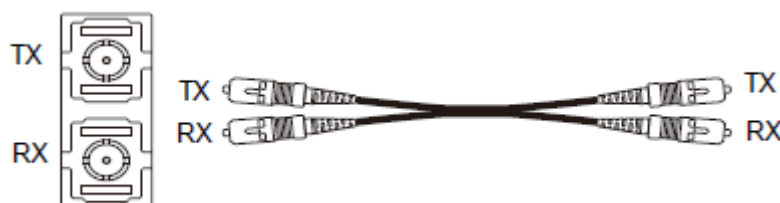

Figure 14 Connection of 100Base-FX Ethernet Port



Caution:

The device uses laser to transmit signals in fibers. The laser meets the requirements of level 1

laser products. Routine operation is not harmful to your eyes, but do not look directly at the fiber port when the device is powered on.

5.3 10/100/1000Base-T(X) Ethernet Port

10/100/1000Base-T(X) Ethernet port is equipped with RJ45 connector. The port is self-adaptive. It can automatically configure itself to work in 10M, 100M, or 1000M state, full or half duplex mode. The port can also adapt to MDI or MDI-X connection automatically. You can connect the port to a terminal or network device with a straight-through or cross-over cable.

- Pin Definition

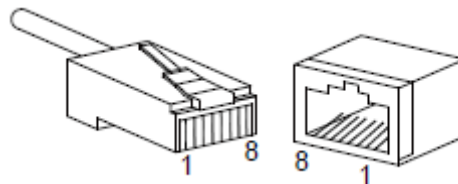

Figure 15 RJ45 Port

Table 7 Pin Definitions of 10/100/1000Base-T(X) RJ45 Port

Pin	MDI-X	MDI
1	Transmit/Receive Data (TRD1+)	Transmit/Receive Data (TRD0+)
2	Transmit/Receive Data (TRD1-)	Transmit/Receive Data (TRD0-)
3	Transmit/Receive Data (TRD0+)	Transmit/Receive Data (TRD1+)
4	Transmit/Receive Data (TRD3+)	Transmit/Receive Data (TRD2+)
5	Transmit/Receive Data (TRD3-)	Transmit/Receive Data (TRD2-)
6	Transmit/Receive Data (TRD0-)	Transmit/Receive Data (TRD1-)
7	Transmit/Receive Data (TRD2+)	Transmit/Receive Data (TRD3+)
8	Transmit/Receive Data (TRD2-)	Transmit/Receive Data (TRD3-)



Note:

"+" and "-" indicate level polarities.

● Wiring Sequence

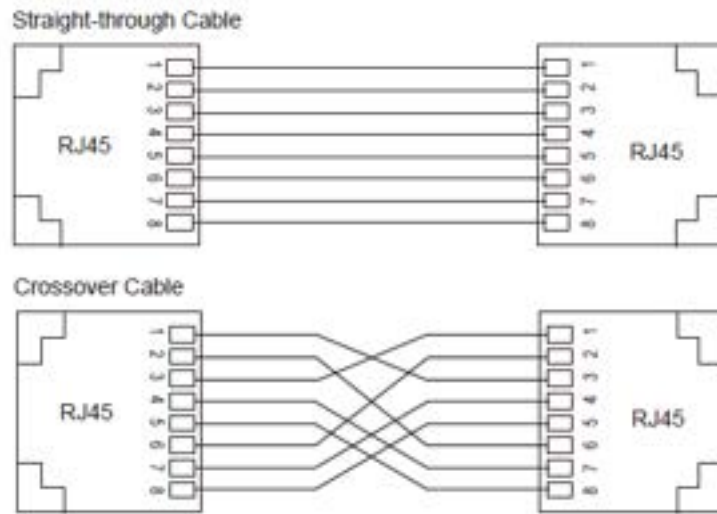

Figure 16 Connection Using Straight-through/Cross-over Cable



Note:

The color of the cable for RJ45 connector meets the 568B standard: 1-orange and white, 2-orange, 3-green and white, 4-blue, 5-blue and white, 6-green, 7-brown and white, and 8-brown.

5.4 1000Base-X, 10/100/1000Base-T(X) SFP slot

1000Base-X, 10/100/1000Base-T(X) SFP slot (gigabit SFP slot) requires an SFP optical/electrical module to enable data transmission. The following table lists the gigabit SFP optical/electrical modules (optional) supported by the series switches.

Table 8 Gigabit SFP Optical/Electrical Modules

Model	Port	MM/SM	Connector	Central Wavelength	Transmission Distance
IGSFP-M-SX-LC-850-0.55	1000Base-X port	MM	LC	850nm	0.55km
IGSFP-S-LX-LC-1310-10	1000Base-X port	SM	LC	1310nm	10km
IGSFP-S-LH-LC-1310-40	1000Base-X port	SM	LC	1310nm	40km
IGSFP-S-ZX-LC-1550-80	1000Base-X port	SM	LC	1550nm	80km
IGSFP-10/100/1000BASE-	10/100/1000Base-	--	RJ45	--	--

T-RJ45	T(X) port				
--------	-----------	--	--	--	--

5.4.1 Gigabit SFP Optical Module

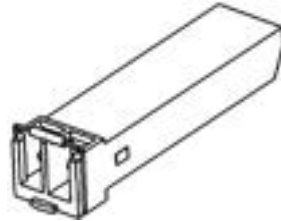

Figure 17 Gigabit SFP Optical Module

An SFP optical module is equipped with LC connector, and each port consists of a TX (transmit) port and an RX (receive) port. To enable communication between Device A and Device B, connect the TX port of Device A to the RX port of Device B, and the RX port of Device A to the TX port of Device B, as shown in the following figure.



Figure 18 Fiber Connection of an SFP Optical Module

- How to Connect the SFP Optical Module

Insert the SFP optical module into the SFP slot in the switch, and then insert the fibers into the TX port and RX port of the SFP module.

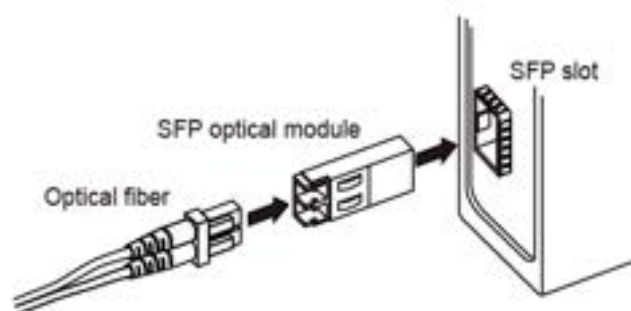

Figure 19 Connecting the SFP Optical Module

Identify the RX port and TX port of an SFP optical module:

1. Insert the two connectors in one end of two fibers into the SFP module, and those in the other end into the peer module.

2. View the corresponding connection status LED:

If the LED is on, the connection is correct. If the LED is off, the link is not connected. This may be caused by incorrect connection of the TX and RX ports. In this case, swap the two connectors at one end of the fibers.



Caution:

- The device uses laser to transmit signals in fibers. The laser meets the requirements of level 1 laser products. Routine operation is not harmful to your eyes, but do not look directly at the fiber port when the device is powered on.
- If the defined transmission distance of an SFP module is longer than 60km, do not use a short fiber (<20km) for connection. If such a short fiber is used, the module will be burned.

5.4.2 Gigabit SFP Electrical Module

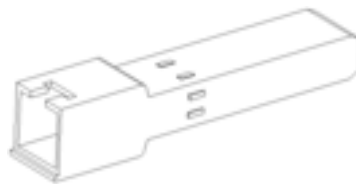

Figure 20 Gigabit SFP Electrical Module

● How to Connect the SFP Electrical Module

Insert the SFP electrical module into the SFP slot in the switch, and then insert the RJ45 connector of the twisted pair into the SFP module.

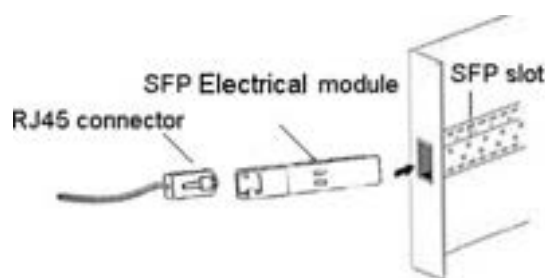

Figure 21 Connecting the SFP Electrical Module

5.5 Console Port

The console ports support RJ45 and Mini USB connectors. You can select either of the two connectors as needed. If you select Mini USB connector for one port and RJ45 connector for

the other, only the console port with the Mini USB connector works when both of the two ports are connected.

If you select the RJ45 connector, use a DB9-RJ45 console cable to connect the 9-pin serial port of a PC to the console port of the switch. If you select the Mini USB connector, you need to install Mini USB driver.exe on the PC. You can find the program in the delivered CD. Then use a USB console cable to connect the USB port of a PC to the console port of the switch. Then you can configure, maintain, and manage the switch by running Hyper Terminal in Windows OS of the PC.

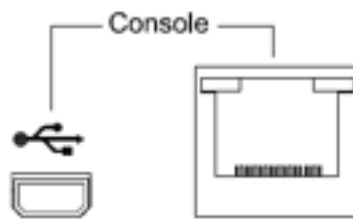

Figure 22 Console Port

● DB9-RJ45 Console Cable

One end of a DB9-RJ45 console cable is the DB9 connector to be inserted into the 9-pin serial port of a PC, and the other end is crimped RJ45 connector to be inserted into the console port of the switch.

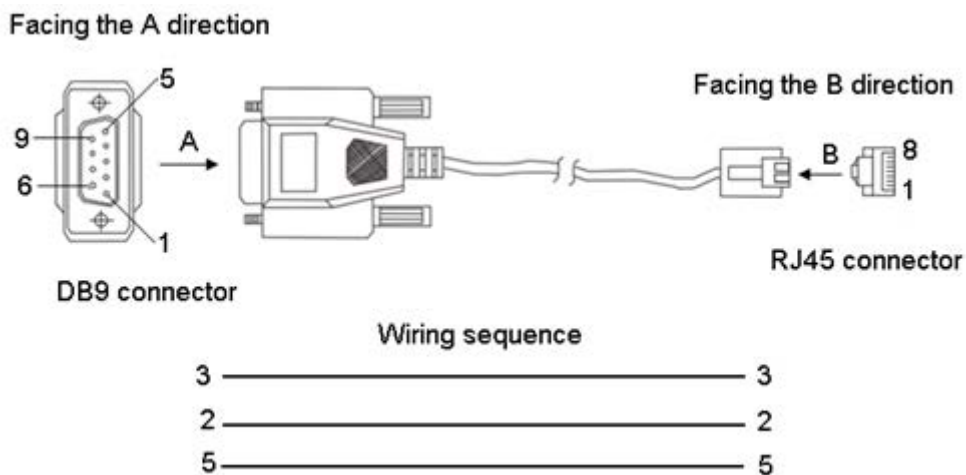

Figure 23 Wiring Sequence of DB9-RJ45 Console Cable

Table 9 Pin Definitions of DB9 Port (9-Pin Serial Port) and RJ45 Port (Console Port)

DB9 Port (9-Pin Serial Port)	RJ45 Port (Console Port)
------------------------------	--------------------------

Pin	Signal	Pin	Signal
2	RXD (Receive data)	2	TXD (Transmit data)
3	TXD (Transmit data)	3	RXD (Receive data)
5	GND (Grounding)	5	GND (Grounding)

● USB Console Cable



Caution:

To use the console port with a Mini USB connector, you need to purchase a USB console cable (optional).

One end of a USB console cable is Mini USB connector to be inserted into the console port of the switch, and the other end is the USB connector to be inserted into the USB port of a PC.



Figure 24 Mini USB Connector

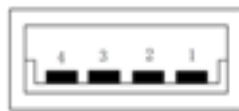

Figure 25 USB Connector

Table 10 Pin Definitions of Mini USB Connector and USB Connector

Mini USB Pin	USB Pin	Definition
1	1	VBUS
2	2	D-
3	3	D+
4	--	ID
5	4	Grounding

5.6 Grounding

Grounding protects the switch from lightning and interference. Therefore, you must ground

the switch properly. You need to ground the switch before it is powered on and disconnect the grounding cable after the switch is powered off.

The switch provides a grounding screw(see Figure 2) on the rear panel for chassis grounding. After crimping one end of the grounding cable to a cold pressed terminal, secure the end to the grounding screw and connect the other end to the earth firmly.



Note:

Cross-sectional area of the chassis grounding cable > 2.5mm²; grounding resistance < 5Ω.

5.7 Power Terminal Block

There is a power terminal block on the rear panel of the device. You need to connect the power wires to the terminal block to provide power to the device. The device supports single (PWR1) and redundant (PWR1 and PWR2) power supply with a 5-pin 5.08mm-spacing plug-in terminal block. When the redundant power supply is used and one power input is faulty, the device can continue operating properly, thereby improving network reliability.



Note:

0.75mm² < Cross-sectional area of the power wire < 2.5mm²; grounding resistance < 5Ω.

- 5-Pin 5.08mm-Spacing Plug-in Terminal Block

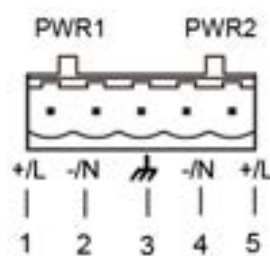



Figure 26 5-Pin 5.08mm-Spacing Plug-in Terminal Block (socket)

Table 11 Pin Definitions of 5-Pin 5.08mm-Spacing Plug-in Terminal Block

No.	Signal	DC Definition	AC Definition
1	+/L	PWR1: +	PWR1: L
2	-/N	PWR1: -	PWR1: N
3		PGND	PGND

4	-/N	PWR2: -	PWR2: N
5	+/L	PWR2: +	PWR2: L



Caution:
For single power supply, only pins 1, 2, and 3 of the terminal block can be connected. Do not use pins 4 and 5.

● **Wiring and Mounting**

Step 1: Ground the device properly according to section 5.6.

Step 2: Remove the power terminal block from the device.

Step 3: Insert the power wires into the power terminal block according to Table 11 and secure the wires.

Step 4: Insert the terminal block with the connected wires into the terminal block socket on the device.

Step 5: Connect the other end of the power wires to the external power supply system according to the power supply requirements of the device. View the status of the power LEDs on the front panel. If the LEDs are on, the power is connected properly.

Wiring and Mounting should meet following specifications.

Table 12 Wiring and Mounting Specifications

Terminal Type	Required Torque	Wire Range (AWG)
Terminal Block Plug	4.5-5.0 lb-in for WEIDMUELLER terminal block	12-24



Caution:

- Before connecting the device to power supply, make sure that the power input meets the power requirement. If connected to an incorrect power input, the device may be damaged.
- To comply with UL restrictions, this equipment must be powered from a source compliant with Class 2.



Warning:

- Do not touch any exposed conducting wire, terminal, or component with a voltage warning

sign, because it may cause damage to humans.

- Do not remove any part or plug in or out any connector when the device is powered on.

5.8 Alarm Terminal Block

The device provides an alarm terminal block on the rear panel for alarm output. When the switch works properly, the normally-open contacts of the alarm relay are closed and the normally-closed contacts are open; when an alarm occurs, the normally-open contacts are open and the normally-closed contacts are closed. The alarm is outputted through a 3-pin 5.08mm-spacing plug-in terminal block.

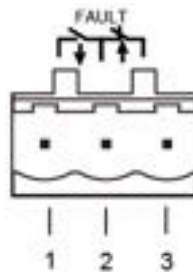

Figure 27 Alarm Terminal Block (socket)

Electrical parameters of the relay:

Max Switch Voltage: 250VAC/220VDC;

Max Switch Current: 2A

Max Switching Power: 60W

Dielectric Strength: 2KV



Note:

Pin 1 and pin 2 are normally-open contacts; pin 2 and pin 3 are normally-closed contacts. When the switch works properly, pin 1 and pin 2 are closed, pin 2 and pin 3 are open; when an alarm occurs, pin 1 and pin 2 are open; pin 2 and pin 3 are closed.

- Wiring and Mounting

Step 1: Remove the alarm terminal block from the switch.

Step 2: Secure the three wires for alarm into the alarm terminal block in the required sequence.

Step 3: Insert the alarm terminal block into its socket.

Wiring and Mounting should meet following specifications.

Table 13 Wiring and Mounting Specifications

Terminal Type	Required Torque	Wire Range (AWG)
Terminal Block Plug	4.5-5.0 lb-in for WEIDMUELLER terminal block	12-24

6 LEDs

Table 14 Front Panel LEDs

LED		State	Description
Power 1 LED-PWR1		On	Power 1 is connected and operates properly.
		Off	Power 1 is not connected or operates abnormally.
Power 2 LED-PWR2		On	Power 2 is connected and operates properly.
		Off	Power 2 is not connected or operates abnormally.
Running LED-Run		Blinking	The CPU operates properly.
		On	The CPU is starting up.
		Off	The CPU does not start up.
Ring LED-Ring		On	Master (DT-Ring mode)/Root (DRP mode)
		Blinking	Slave (DT-Ring mode)/B-Root or Normal (DRP mode)
		Off	No ring
Alarm LED-Alarm		On	An alarm occurs.
		Off	No alarm occurs.
Synchronization Finish LED-Lock		On	The switch has completed PTP synchronization.
		Blinking	The switch is performing PTP synchronization
		Off	The switch has not performed PTP synchronization.
Port speed LED-Slot (1-7) Speed (1-4)	10/100/1000Base-T(X) Ethernet port	On	1000M working state (1000Base-TX)
		Off	10/100M working state (10/100Base-T(X)) or no connection
	1000Base-X Ethernet port	On	1000M working state (1000Base-TX)
		Off	100M working state (100Base-FX) or no connection

	10/100Base-T(X)	On	100M working state (100Base-TX)
	Ethernet port	Off	10M working state (10Base-T) or no connection
	100Base-FX	On	100M working state (100Base-FX)
	Ethernet port	Off	No connection
Port connection status LED- Slot (1-7) Link/ACT (1-4)		On	Effective port connection
		Blinking	Ongoing network activities
		Off	No effective port connection

Table 15 Rear Panel LEDs

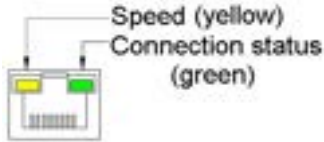
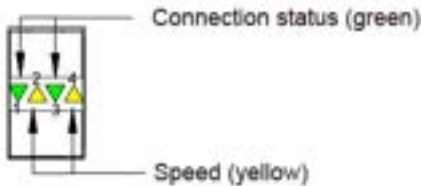
LED		State	Description
			
Port speed LED	10/100/1000Base-T(X)	On	1000M working state
	Ethernet port	Off	10/100M working state or no connection
	10/100Base-T(X)	On	100M working state
	Ethernet port	Off	10M working state or no connection
Port connection status LED		On	Effective port connection
		Blinking	Ongoing network activities
		Off	No effective port connection
			
<p>LED 1 and LED 2 indicate the status of the upper gigabit SFP slot, while LED 3 and LED 4 indicate the status of the lower gigabit SFP slot.</p>			
1000Base-X, 10/100/1000Base-T(X) SFP slot speed LED	Gigabit SFP optical module	On	1000M working state (1000Base-TX)
		Off	100M working state (100Base-FX) or no connection

	Gigabit SFP electrical module	On	1000M working state (1000Base-TX)
		Off	10/100M working state (10/100Base-T(X)) or no connection
1000Base-X, 10/100/1000Base-T(X) SFP slot connection status LED		On	Effective port connection
		Blinking	Ongoing network activities
		Off	No effective port connection



Caution:

- The speed LEDs of 100M ports on the front and rear panels of SICOM3028GPT-L2GT-MB, SICOM3028GPT-L2G-MB, SICOM3028GPT-L3GT-MB, and SICOM3028GPT-L3G-MB are never on.
- When SM6.6-PTP-BO-0.5U, SM6.6-GPS-OI-0.5U, and SM6.6-GPS-OI-FI-0.5U are inserted into slots, the corresponding indicators on the front panel are off all the time.
- When SM6.6-4D-232/422/485-0.5U, SM6.6-4D-A-4RS232/422/485-0.5U, and SM6.6-PTP-over-E1-0.5U are inserted into slots, the corresponding indicators of the fourth group on the front panel run based on the state of 10/100Base-T(X) port.
- When SM6.6-HSR/PRP-GE-0.5U, and SM6.6-HSR/PRP-GX-0.5U are inserted into slots, the corresponding indicators of the fourth group on the front panel run based on the state of 10/100/1000Base-T(X) port.
- When SM6.6-MFA-0.5U are inserted into slots, the corresponding indicators of the fourth group on the front panel run based on the state of 1000M optical port.

7 Switch Access

You can access the switch in any of the following ways:

7.1 Access through Console Port



Caution:

The console ports support RJ45 and Mini USB connectors. You can select either of the two connectors as needed. If you select Mini USB connector for one port and RJ45 connector for the other, only the console port with the Mini USB connector works when both of the two ports are connected.

- RJ45 Connector

Step 1: Connect the console port of the switch to the 9-pin serial port of a PC with the delivered DB9-RJ45 console cable.

Step 2: Open Hyper Terminal in Windows OS. On the computer's desktop, click Start → All Programs → Accessories → Communications → Hyper Terminal.

Step 3: Create a connection "Switch", as shown in the following figure.

- Mini USB Connector

Step 1: Install Mini USB driver.exe. You can find the program in the delivered CD. Connect the USB port of the PC to the console port of the switch with the USB console cable.

Step 2: Open Hyper Terminal in Windows OS. On the computer's desktop, click Start → All Programs → Accessories → Communications → Hyper Terminal.

Step 3: Create a connection "Switch", as shown in the following figure.



Figure 28 Creating a Connection

Step 4: Connect the communication port in use, as shown in the following figure.



Figure 29 Selecting a Serial Port



Note:

To confirm the communication port in use, right-click [My Computer] and select [Property]. Click [Hardware] → [Device Manager] → [Port] to view the communication port.

Step 5: Set port parameters (Bits per second: 115200, Data bits: 8, Parity: None, Stop bits: 1, and Flow control: None), as shown in the following figure.



Figure 30 Setting Port Parameters

Step 6: Click OK to enter the switch CLI. Then the following commands can be used to perform operations.

Table 16 CLI Commands

View	Command	Description
General mode	SWITCH>enable	Enter the privileged mode.
Privileged mode	SWITCH#show interface vlan 1	Query the default IP address of the switch.
Privileged mode	SWITCH#show version	Query the version of the switch.
Privileged mode	SWITCH#reboot	Restart the switch.
Privileged mode	SWITCH#set default SWITCH#save	Restore the factory default settings (including the IP address).
Privileged mode	SWITCH#config terminal	Enter the configuration mode.

7.2 Access through Telnet

Step 1: Connect the network port of a PC to the Ethernet port of the switch with a network cable.

Step 2: On the Windows desktop, click Start and Run. The Run dialog box is displayed. Enter "telnet *IP address*". For example, if the IP address of the serial port module is 192.168.0.2 (default IP address of the device), enter "telnet 192.168.0.2" in the dialog box.

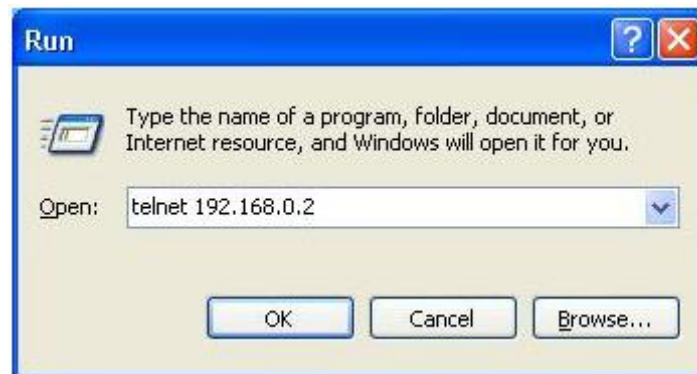

Figure 31 Access through Telnet

Step 3: Click OK. The Telnet CLI is displayed. Then you can run the commands in Table 16 to perform operations.

7.3 Access through Web

Step 1: Connect the network port of a PC to the Ethernet port of the switch with a network cable.

Step 2: Enter the IP address of the device in the address box of the browser. The user login interface is displayed. You can log in to the Web UI by default user name "admin" and password "123".



Note:

- IE8.0 or a later version is recommended.
 - For details about how to access the device and other operations, refer to the Web operation manual in the delivered CD.
-

8 Basic Features and Specifications

Power Requirements

Power Identifier	Rated Voltage Range	Maximum Voltage Range
L3 (24DC)	24VDC	18-36VDC
L1 (48DC)	48VDC	36-72VDC
HV (220AC/DCW)	100-240VAC, 50/60Hz; 110-220VDC	85-264VAC/77-300VDC
Terminal block	5-pin 5.08mm-spacing plug-in terminal block	

Rated Power Consumption

Rated power consumption	40W
-------------------------	-----

Physical Characteristics

Housing	Metal, fanless
Protection class	IP40
Installation	19 inch 1U rack mounting
Dimensions (W×H×D)	440mm×44mm×360mm (excluding connectors and mounting brackets)
Weight	10Kg (MAX)

Environmental Limits

Operating temperature	-40°C~+85°C
Storage temperature	-40°C~+85°C
Ambient relative humidity	5%~95% (non-condensing)
Pollution degree	2
Insulation class	3

MTBF

MTBF	SICOM3028GPT-L3GT, SICOM3028GPT-L3FT: 371000h
------	---

	SICOM3028GPT-L3G, SICOM3028GPT-L3F: 368000h SICOM3028GPT-L2GT, SICOM3028GPT-L2FT: 359000h SICOM3028GPT-L2G, SICOM3028GPT-L2F: 360000h
Warranty	
Warranty	5 years

KYLAND

FAX: +86-10-88796678

Website: <http://www.kyland.com>

Email: support@kyland.com

Address: Building No.2, Shixing Avenue 30#
shijingshan District, Beijing, China

For more information about KYLAND products,
please visit our website:

<http://www.kyland.com>