

GPS Clock Synchronization Module Hardware Installation Manual

KYLAND

Kyland Technology Co., LTD.

Publication Date: Sep. 2016

Version: V1.0

Customer Service Hotline: (+8610) 88796676

FAX: (+8610) 88796678

Website: <http://www.kyland.cn>

E-mail: support@kyland.biz

**GPS clock synchronization module
Hardware Installation Manual**

Disclaimer: Kyland Technology Co., Ltd. tries to keep the content of this manual as accurate and as updated as possible. This document is not guaranteed to be error-free, and we reserve the right to amend it without notice to users.

**Copyright © 2016 Beijing KYLAND Technology CO., LTD.
All rights reserved.**

No part of this documentation may be excerpted, reproduced, translated, annotated or duplicated, in any form or by any means without the prior written permission of KYLAND Corporation.

Notice for Safety Operation

This product performs reliably as long as it is used according to the guidance. Artificial damage or destruction of the equipment should be avoided.

- Read this manual carefully and keep it for future reference;
- Do not place the equipment near water sources or damp areas;
- Do not place anything on power cable or put the cable in unreachable places;
- Do not tie or wrap the cable, which may cause a fire risk;
- Power connectors and other equipment connectors should be firmly interconnected and checked frequently;
- Do not repair the equipment by yourself, unless it is clearly specified in the manual;
- Please keep the equipment clean; if necessary, wipe the equipment with soft cotton cloth.

In the following cases, please immediately shut down your power supply and contact your Kyland representative:

- Water gets into the equipment;
- Equipment damage or shell damage;
- Equipment operation or performance has abnormally changed;
- The equipment emits odor, smoke or abnormal noise.

Contents

1	Product Overview
	4
2 Structure and Interface	4
3 Installation.....	5
3.1 Dimension Drawing	5
3.2 Installing the Module.....	6
3.2.1 Installing the Module	6
3.2.2 Removing the Module	9
4 Cable Connection	9
4.1 GPS Signal Input Port.....	9
4.1.1 Installing GPS Antenna.....	10
4.2 PPS Output Port.....	15
5 LED Indicators.....	15
6 Management Access	16
6.1 Connected through Console Port	16
6.2 Connected through Ethernet Cable.....	19
6.3 Web Access.....	21
7 Product Configuration Information.....	22
8 Basic Features and Specifications	23

1 Product Overview

GPS clock synchronization module is specifically designed for switches including SICOM3028GPT-L2FT, SICOM3028GPT-L2GT, SICOM3028GPT-L3FT and SICOM3028GPT-L3GT, which support PTP protocol. The GPS receiver and precise clock included in the module can provide a very precise GPS signal for host switches.

GPS clock synchronization module provides one GPS signal input port and one PPS output port.

2 Structure and Interface

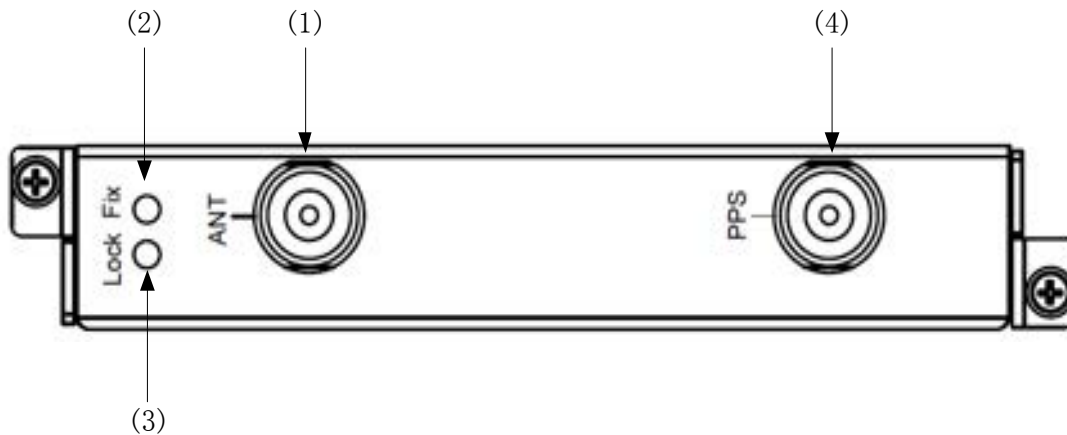

Figure 1 GPS clock synchronization module

Table 1 GPS clock synchronization module Panel

Number	Diagram Label	Description
1	ANT	GPS signal input port, BNC connector
2	Fix	Position Satellite LED
3	Lock	Frequency Lock LED
4	PPS	PPS output port, BNC connector

3 Installation

3.1 Dimension Drawing

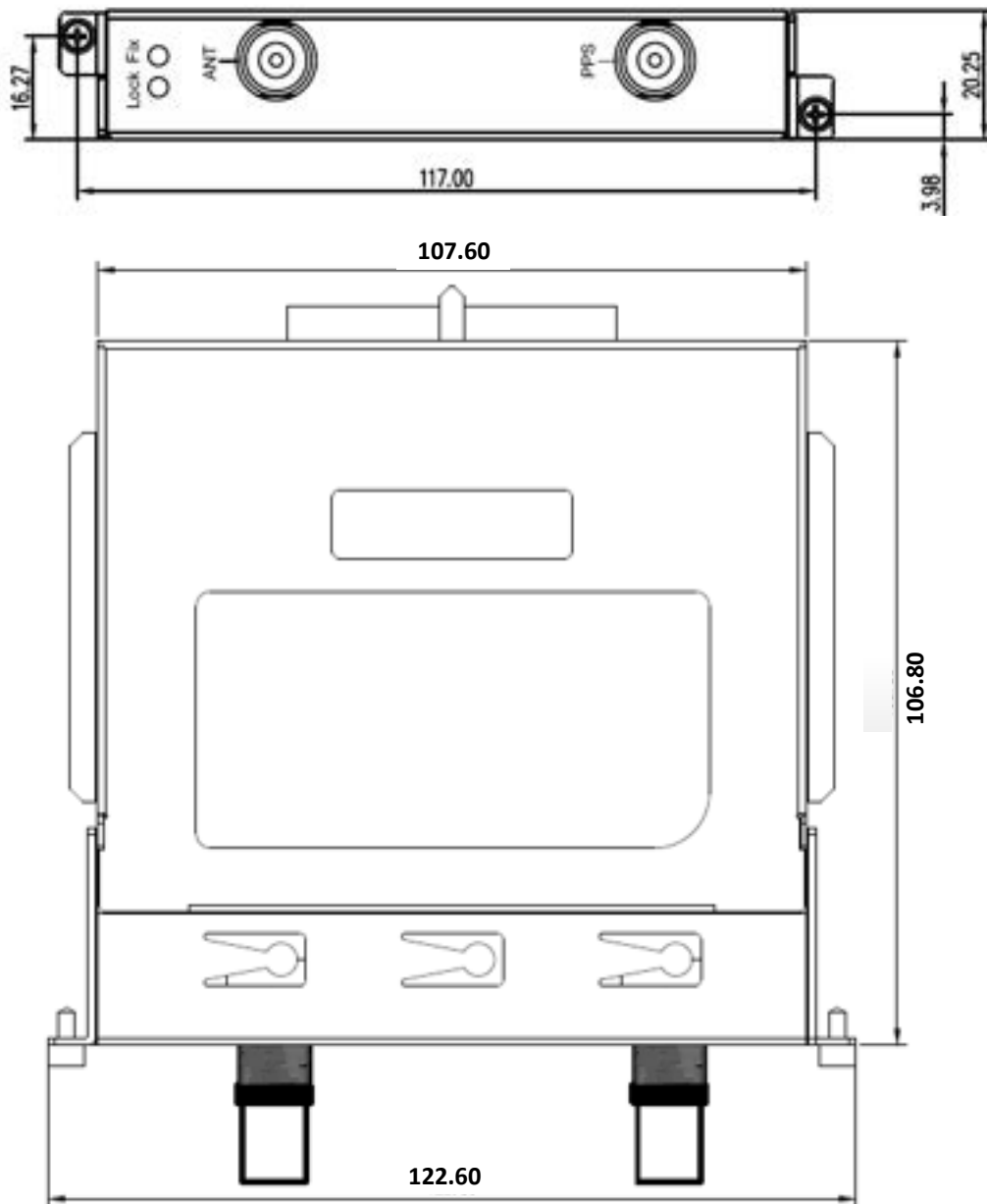

Figure 2 Module Dimension Drawing

3.2 Installing the Module

Note: We recommend that the modules be installed and removed while the power is disconnected.

3.2.1 Installing the Module

The series switches provide six 0.5U Slots (Slot2-Slot7) in the rear panel. The GPS clock synchronization module can be installed into the random 0.5U slots as needed.

The installation method for upper slots (Slot2, 4 and 6) is to install the module facing up and lower slots (Slot3, 5 and 7) should be installed facing down.

- GPS clock synchronization module installation in upper slots(Slot2,Slot4 and Slot6)

Step 1: Place the module with the diagram label facing up. Insert the guide rail of module into the guide rail slot, as shown in Figure 3 , and then push the module in along the guide rail slot until the module is in close contact with the switch.

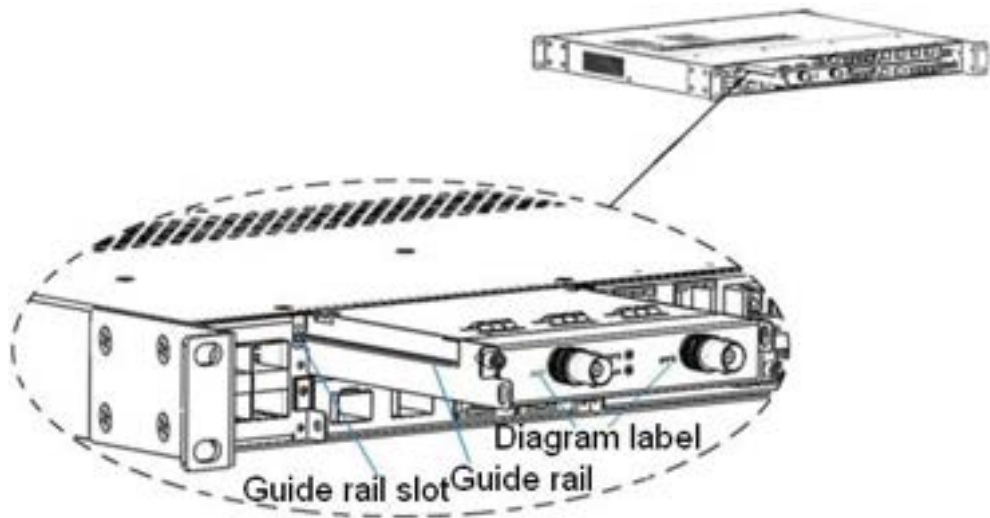

Figure 3 Module Installation 1

Step 2: Secure the module into the switch chassis with two screws (M2.5x5), as shown in Figure 4.

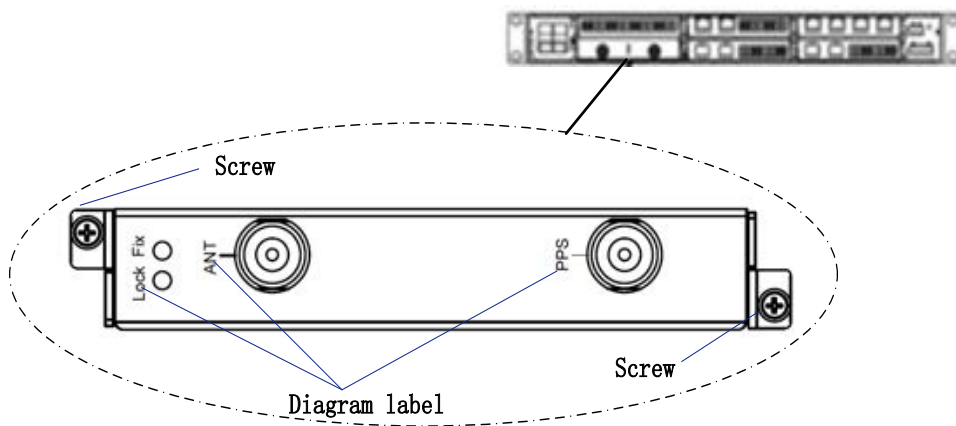

Figure 4 Module Installation 2

- GPS clock synchronization module installation in lower slots(Slot3,Slot5 and Slot7)

Step 1: Place the module with the diagram label upside down. Insert the guide rail of module into the guide rail slot, as shown in Figure 5,

and then push the module in along the guide rail slot until the module is in close contact with the switch.

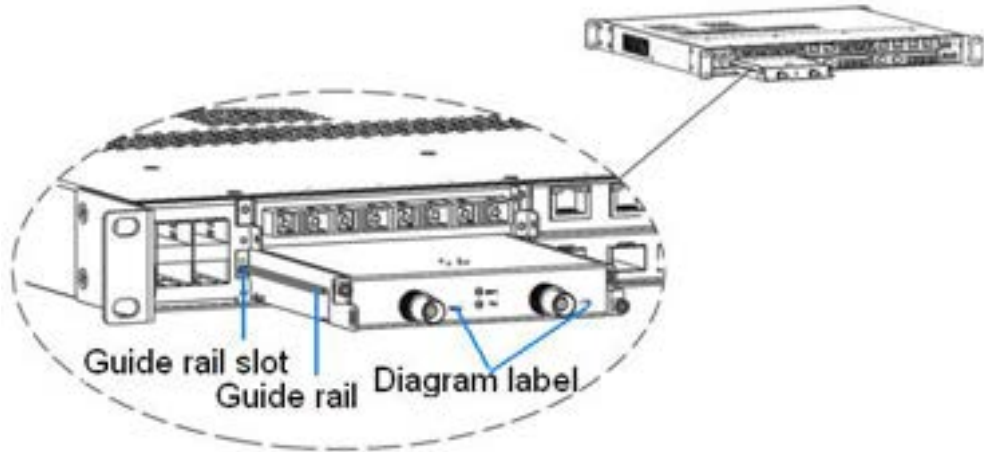

Figure 5 Module Installation 3

Step 2: Secure the module into the switch chassis with two screws (M2.5x5), as shown in Figure 6 .

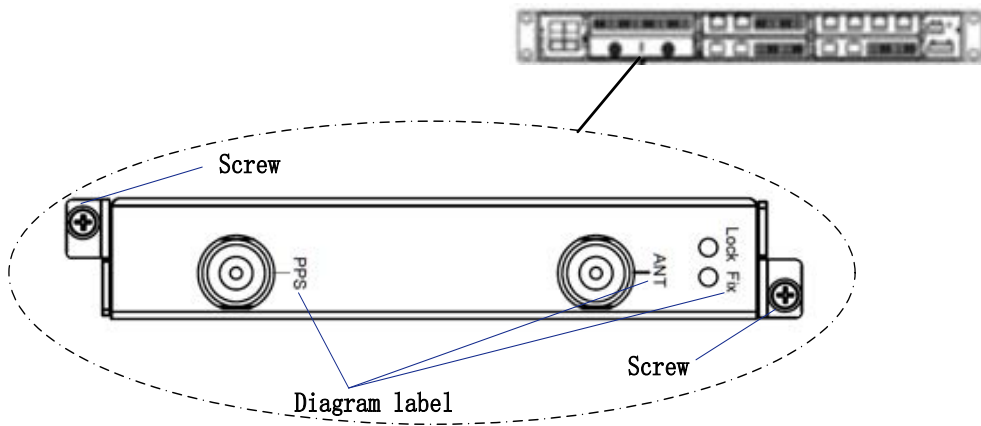

Figure 6 Module Installation 4

3.2.2 Removing the Module

The specific mounting steps are as follows: (removal for upper and lower slots is the same)

Step 1: Remove the two fastening screws of the module and switch chassis.

Step 2: Insert the long tab into the handle of the module, as shown in Figure 7; then move the puller left to ensure adequate space for inserting the short tab.

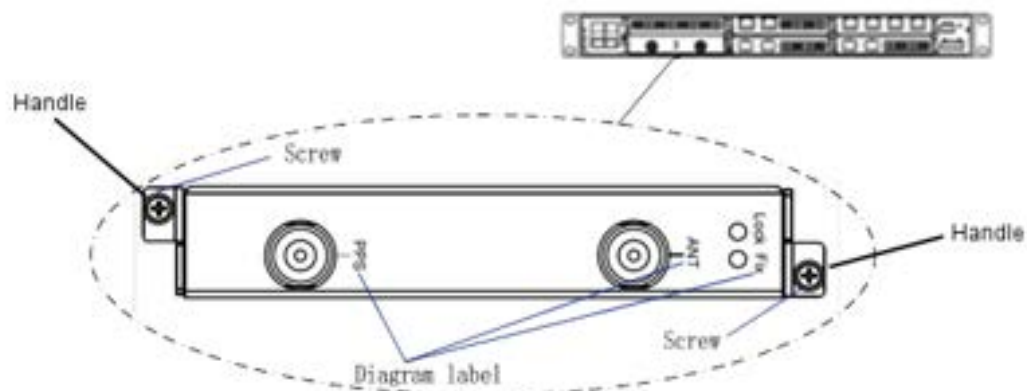

Figure 7 the Module Removal 1

Step 3: Pull the handle outwards with your fingers. The module will pop-up. Pull the module outwards along the guide rail slot, until it completely comes out of the switch chassis.

4 Cable Connection

4.1 GPS Signal Input Port

GPS signal input port can be used to connect and supply power for GPS antenna (as shown in Table 6 Product Optional Accessories) that can receive satellite signal; the supplied power voltage is 5VDC. The port is

assembled with BNC connector as shown in Figure 8.



Figure 8 GPS Signal Input Port

4.1.1 Installing GPS Antenna

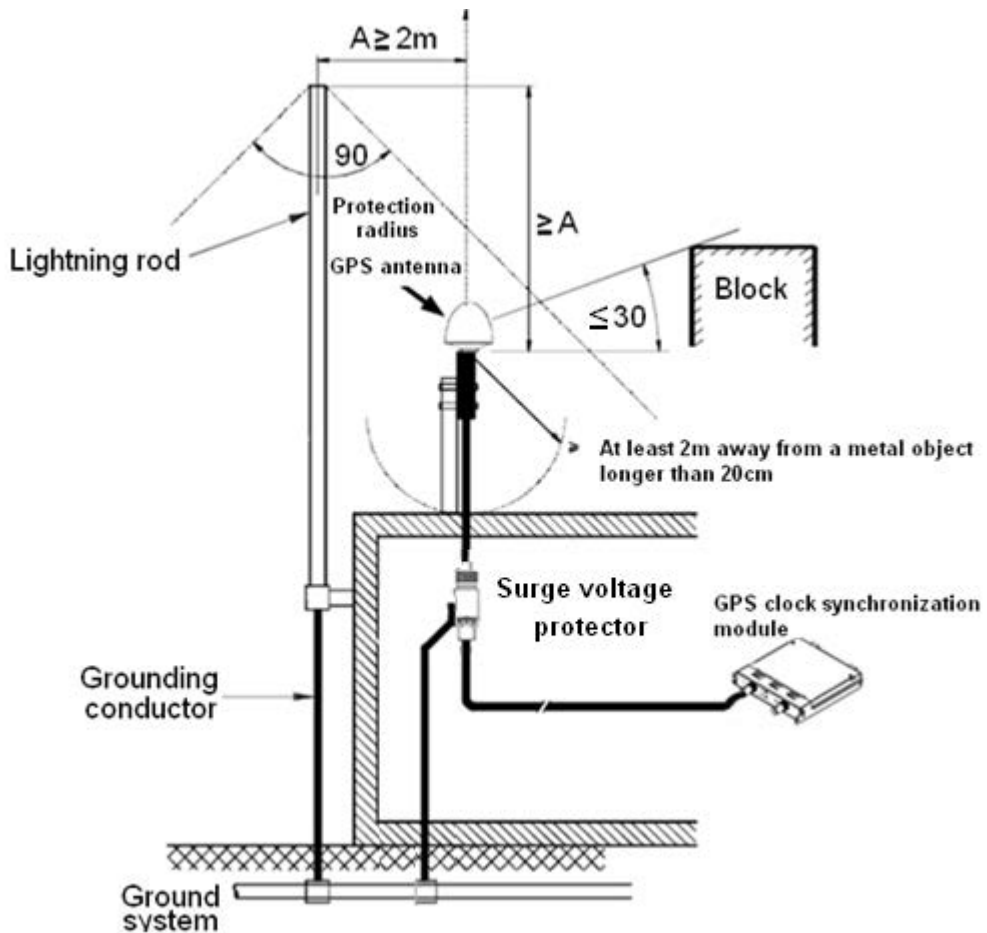

Figure 9 Installing GPS Antenna

- Installation position

1. Lower than the top of the lightning rod

To be protected by the lightning rod, the GPS antenna should be positioned lower than the top of the lightning rod.

2. Unshielded view of the sky

The GPS antenna should be positioned with a clear view of the sky. The biggest obstacle in the surrounding should not block a horizontal section larger than 30 degrees, that is, the vertical upward view without a block should be larger than 120 degrees, as shown in Figure 9.

3. Free from interference

To prevent interference caused by reflected wave, the GPS antenna should be positioned at least 2m away from a metal object longer than 20cm, as shown in Figure 9.

The GPS antenna should not be installed near another transmitting or receiving device, below a microwave antenna or high-voltage cable, or directly in the radiation direction of another transmitting antenna.

A minimum of 2m distance should be kept between any two GPS antennas. You are advised to install multiple GPS antennas in different locations to prevent mutual interference.

● Installation steps

You can choose whether to install the surge voltage protector as needed. Table 2 lists specific installation steps.

Table 2 GPS Antenna Installation

	GPS Antenna Installation	GPS Antenna Installation (with
--	---------------------------------	---------------------------------------

	(without surge voltage protector)	surge voltage protector)
Step 1: Purchase product optional accessories (as shown in Table 6)	20-meter low-loss RF coaxial cable (DT-XL-LMR400-TNC-BNC-20m)	<ol style="list-style-type: none"> 1. Adapter for low-loss RF coaxial cable (DT-ZJQ-BNC-TNC-01) 2. 20-meter low-loss RF coaxial cable (DT-XL-LMR400-TNC-BNC-20m) 3. 2-meter low-loss RF coaxial cable (DT-XL-LMR400-TNC-BNC-2m) 4. Surge voltage protector (DT-SP-01)
Step 2: Connect GPS antenna cables for	Lead the TNC (male) of the low-loss RF coaxial cable (DT-XL-LMR400-TNC-BNC-20m) through the opening of the antenna bracket. Connect the TNC (male) of the low-loss RF coaxial cable (DT-XL-LMR400-TNC-BNC-20m) to the TNC (female) of the GPS antenna. Tighten the bracket with the GPS antenna.	
Step 3: Secure GPS antenna	Secure the antenna bracket with a bolt at a higher position, for example, the top of a building. Parallel the receiving surface of the GPS antenna with the ground for optimal signal reception.	
Step 4: Connect GPS clock synchronization module	Connect the BNC (male) of the low-loss RF coaxial cable (DT-XL-LMR400-TNC-BNC-20m) to the BNC (female) of the GPS signal input port on the GPS clock synchronization module.	<ol style="list-style-type: none"> 1. Connect the BNC (male) of the low-loss RF coaxial cable (DT-XL-LMR400-TNC-BNC-20m) to BNC (female) of the adapter for low-loss RF coaxial cable. (DT-ZJQ-BNC-TNC-01) 2. Solder a grounding conductor (cross-sectional area $\geq 4\text{mm}^2$, as

		<p>short as possible) to the GND of the surge voltage protector.</p> <p>Connect the grounding conductor to the ground system.</p> <p>3. Connect the TNC (female) of the adapter for low-loss RF coaxial cable (DT-ZJQ-BNC-TNC-01) to TNC (male) of the surge voltage protector.</p> <p>4. Connect the low-loss RF coaxial cable (DT-XL-LMR400-TNC-BNC-2m) to the TNC (female) of the surge voltage protector and the BNC (female) of the GPS signal input port on the GPS clock synchronization module respectively.</p>
--	--	--

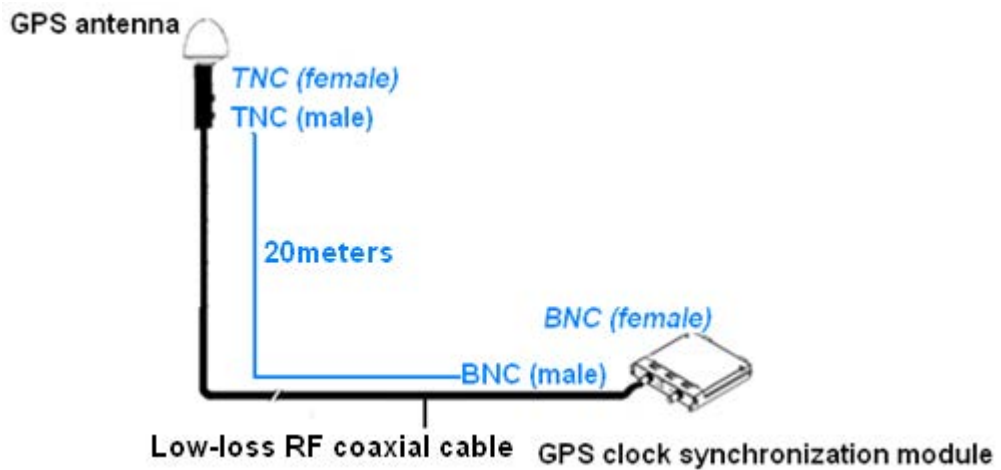

Figure 10 Connecting GPS Antenna to GPS Clock Synchronization Module (no surge voltage protector)

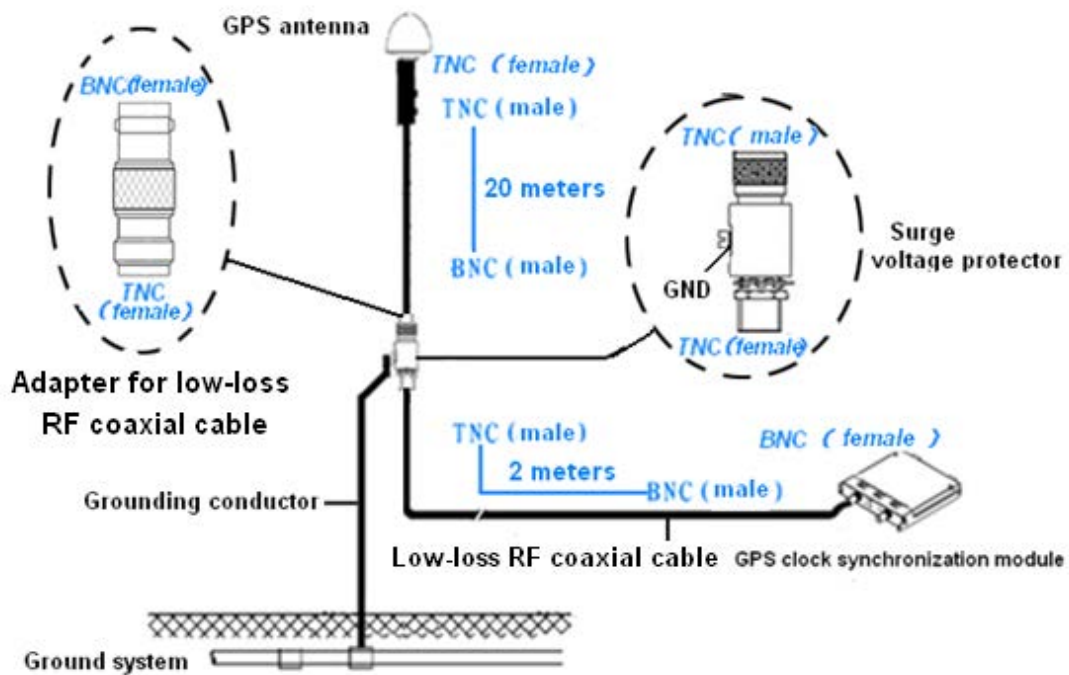

Figure 11 Connecting GPS Antenna to GPS Clock Synchronization Module (including surge voltage protector)

Note: It is recommended to install the surge voltage protector indoor. If it is installed outdoor, you must take waterproof measures.

4.2 PPS Output Port

The port assembled with BNC connector can be used for PPS (Pulses Per Second) output.



Figure 12 PPS Output Port

Note: PPS output, TTL +5V level, trigger by rising edge, pulse width 20ms-200ms, software adjustable step is 1ms.

5 LED Indicators

Table 3 Panel LED

LED	State	Description
Position Satellite LED		
Fix	ON	GPS antenna has positioning for at least 4 satellites and effective time obtained from satellite .
	OFF	GPS antenna has positioning for less than 4 satellites.
Frequency Lock LED		
Lock	ON	System clock has locked.
	Blinking (1HZ)	Free oscillations
	OFF	System clock has not locked.

6 Management Access

GPS clock synchronization module is managed by the host switch (SICOM6028GPT, SICOM6424PT, SICOM3028GPT or SICOM3424PT).

The host switch manages the module through CLI, SNMP or Web browser.

Finishing the installation of the module as shown in 3.2.1, we can search for the information of module through Console interface, telnet or Web browser.

6.1 Connected through Console Port

1. Install the driver for Mini USB onto your PC. The driver “Mini USB driver.exe” is in the software download folder, which is on the supplied CD.
2. Use the Console cable that is equipped with Mini USB connector at one end and USB connector at the other end to connect the Console interface on the switch with the USB port on PC.
3. On Windows desktop, click Start → All programs → Accessories → Communications → HyperTerminal.



Figure 13 Hyper Terminal

4. Build a new connection named "aa"

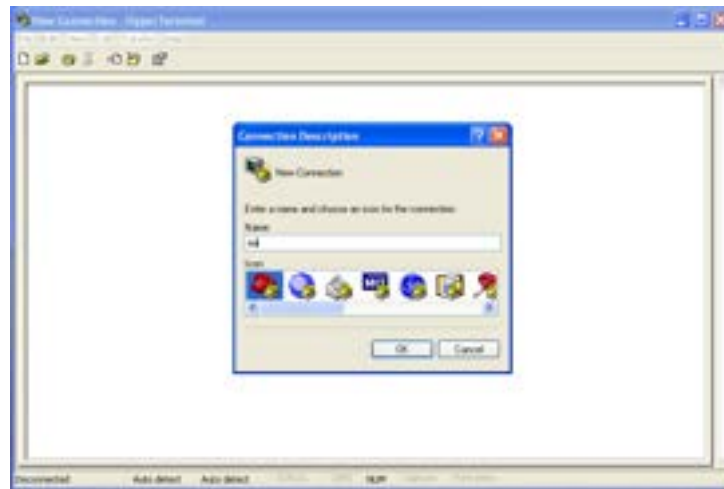

Figure 14 New Connection

5. Select COM port as the connection type.

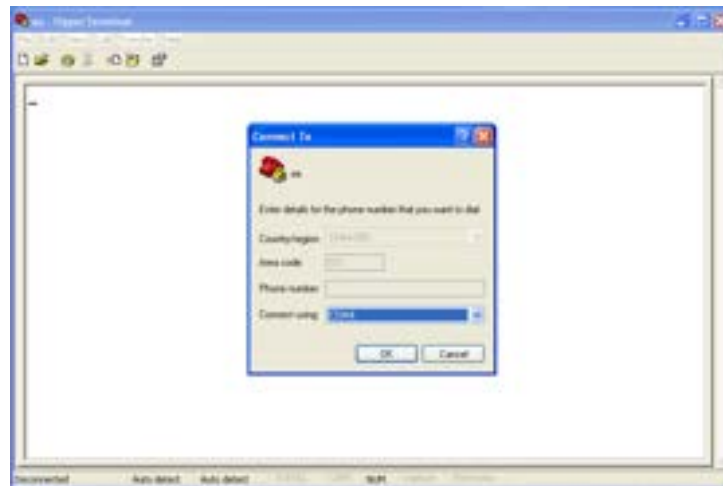

Figure 15 Choose Port

6. Set the parameters of COM port (Bits per second: 115200, Data bits: 8, Parity: None, Stop bits: 1, Flow control: None)



Figure 16 Set COM Parameters

7. Click “OK” to enter the CLI interface, and type in the command “enable” to enter management view, and then type in the command “ show interface gps” to search for current information of the module.

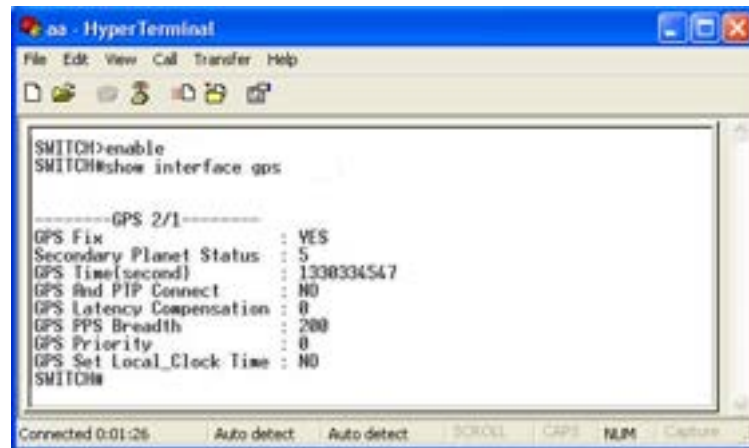

Table 4 describes the display information that appears after clicking the command “show interface gps”

Table 4 Display Information Description

Display Information	Description
GPS Fix	GPS antenna positioned at least 4 satellites.
Secondary Planet Status	the number of the satellites positioned
GPS Time(second)	GPS time
GPS And PTP Connect	Enable/disable the connection of GPS and PTP
GPS Latency Compensation	GPS latency compensation
GPS PPS Breadth	the width of GPS PPS
GPS Priority	the priority of the GPS clock synchronization module
GPS Set Local_Clock Time	Enable/disable the conversion from GPS time to local clock time

6.2 Connected through Ethernet Cable

1. Connect any RJ45 port of the switch with the Ethernet port of a personal computer with a RJ45 cable.
2. Open Run window from the start menu, then input “telnet + ‘IP address’”.

The default IP address is 192.168.0.2.

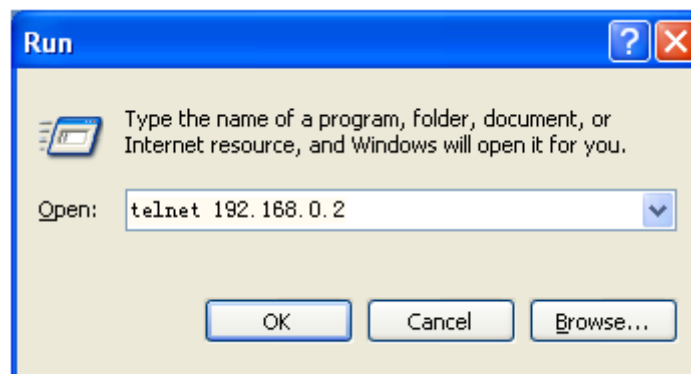

Figure 17 Enter Telnet

3. Click “OK” to enter the Telnet configuration interface as shown in Figure 18. Login with default user name “admin” and password “123”, and type in the command “enable” to enter management view, and then type in the command “show interface gps” to search for current information of the module.

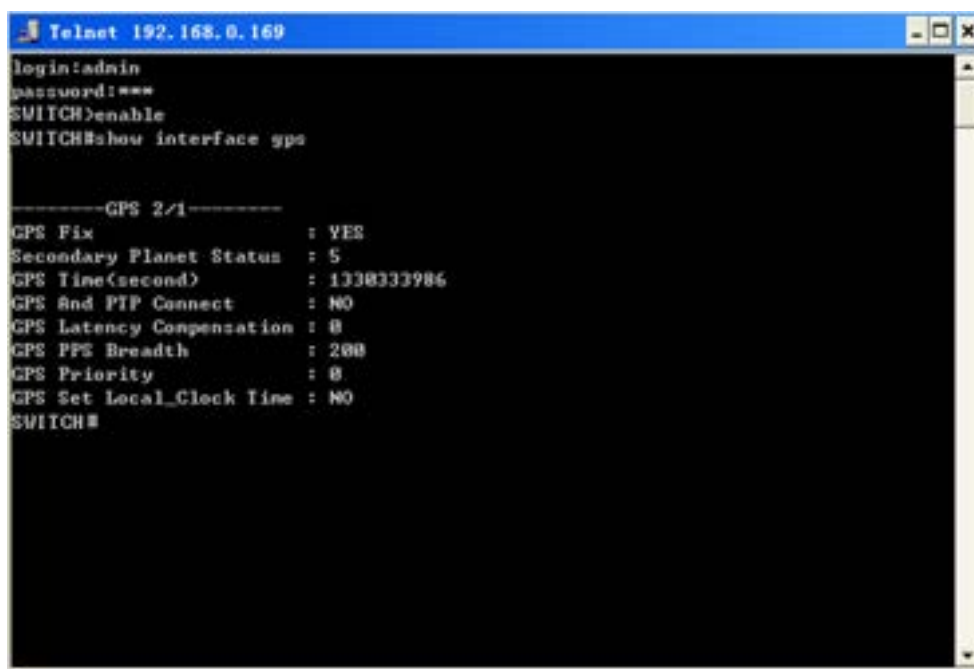

Figure 18 Telnet Configuration Interface

The description of display information that appears after clicking the command “show interface gps” is shown in Table 4.

6.3 Web Access

1. Connect the Ethernet port on the PC to any RJ45 port on the switch.
2. Input the IP address of the current switch in web browser, the default IP is **192.168.0.2**. The Web interface access screen will appear as shown in Figure 19 (Take SICOM6028GPT for example); Enter the Web management page as shown in Figure 20 with default user name “**admin**” and password “**123**”.



Figure 19 Web Interface Access Screen

3. As shown in Figure 20 below, there is a navigation tree menu on the left side; click Gps configuration (in red)→Gps configuration, and the Gps configuration interface will appear on the right; you can make and search for GPS configuration on upper and lower side of the Gps configuration interface separately. Refer to Table 4 for the description of the current GPS configuration information.

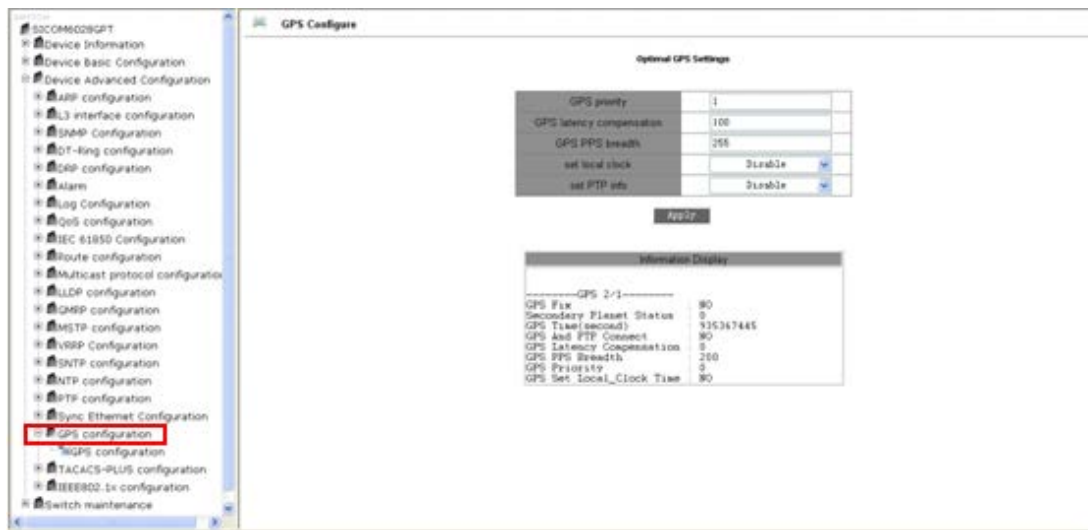

Figure 20 GPS Configuration Interface

Note: We recommend IE version 8.0 or greater.

7 Product Configuration Information

Table 5 Product Configuration

Model	Interface Description
SM6.6-GPS-OI-0.5U	GPS clock synchronization module, conversion from GPS signal to PTP, supports one GPS signal input (BNC connector), one PPS output (BNC connector)

Table 6 Product Optional Accessories

Model	Description
DT-GPS-ANT-01	Weatherproof housing GPS Antenna with 5VDC, TNC female connector
DT-SP-01	Surge voltage protector (with one TNC female and one

	TNC male connector) to be connected to the coaxial cables of GPS antenna.
DT-XL-LMR400-TNC-BNC-20m	20-meter low-loss RF coaxial cable with one TNC male connector and one BNC male connector
DT-XL-LMR400-TNC-BNC-2m	2-meter low-loss RF coaxial cable with one TNC male connector and one BNC male connector
DT-ZJQ-BNC-TNC-01	Adapter for low-loss RF coaxial cable with one BNC female connector and one TNC female connector

8 Basic Features and Specifications

- Physical Characteristics
 - Input: one GPS signal input
 - Port Connector: BNC
 - Receiver: 14 channels GPS C/A coding receiver
- Environment Limits
 - Operating Temperature: 0°C~+50°C
 - Storage Temperature: -20°C~+70°C
 - Ambient Relative Humidity: 5%~95% (non-condensing)
- Sensitivity
 - Tracking Sensitivity: -160 dBm
 - Acquisition Sensitivity: -155 dBm
- Frequency
 - 1575.42MHZ±1.023MHZ
- Power Consumption
 - 4.5W (at starting up)
 - 3W (operating)

- Weight
300g
- Warranty
5 years

For more information about KYLAND products, please visit our website:

<http://www.kyland.cn/>