

SICOM6416G/SICOM3416G Series Industrial Ethernet Switches Hardware Installation Manual

Publication Date: June. 2021

Version: V1.0

KYLAND

SICOM6416G/SICOM3416G Series

Industrial Ethernet Switches Hardware Installation Manual

Disclaimer: Kyland Technology Co., Ltd. tries to keep the content of this manual as accurate and as updated as possible. This document is not guaranteed to be error-free, and we reserve the right to amend it without notice to users.

All rights reserved. No part of this documentation may be excerpted, reproduced, translated, annotated or duplicated, in any form or by any means without the prior written permission of KYLAND Corporation.

Copyright © 2021 Kyland Technology Co., Ltd.

Notice for Safety Operation

The product performs reliably as long as it is used according to the guidance. Artificial damage or destruction of the device should be avoided. Before using the device, read this manual carefully for personal and equipment safety. Please keep the manual for further reference. Kyland is not liable to any personal or equipment damage caused by violation of this notice.

- Do not place the device near water sources or damp areas. Keep the ambient relative humidity within the range from 5% to 95% (non-condensing).
- Do not place the device in an environment with high magnetic field, strong shock, or high temperature. Keep the working and storage temperatures within the allowed range.
- Install and place the device securely and firmly.
- Please keep the device clean; if necessary, wipe it with a soft cotton cloth.
- Do not place any irrelevant materials on the device or cables. Ensure adequate heat dissipation and tidy cable layout without knots.
- Wear antistatic gloves or take other protective measures when operating the device.
- Avoid any exposed metal wires because they may be oxidized or electrified.
- Install the device in accordance with related national and local regulations.
- Before power-on, make sure the power supply is within the allowed range of the device. High voltage may damage the device.
- Power connectors and other connectors should be firmly interconnected.
- Do not plug in or out the power supply with wet hands. When the device is powered on, do not touch the device or any parts with wet hands.
- Before operating a device connected to a power cable, remove all jewelry (such as rings, bracelets, watches, and necklaces) or any other metal objects, because they may cause electric shock or burns.
- Do not operate the device or connect or disconnect cables during an electrical storm.
- Use compatible connectors and cables. If you are not sure, contact our sales or technical support personnel for confirmation.

- Do not disassemble the device by yourself. When an anomaly occurs, contact our sales or technical support personnel.
- If any part is lost, contact our sales or technical support personnel to purchase the substitute. Do not purchase parts from other channels.
- Dispose of the device in accordance with relevant national provisions, preventing environmental pollution.

In the following cases, please immediately shut down your power supply and contact your Kyland representative:

- Water gets into the equipment.
- Equipment damage or shell damage.
- Equipment operation or performance has abnormally changed.
- The equipment emits odor, smoke or abnormal noise.

NOTE: This equipment has been tested and found to comply with the limits for a Class A digital device, pursuant to part 15 of the FCC Rules. These limits are designed to provide reasonable protection against harmful interference when the equipment is operated in a commercial environment. This equipment generates, uses, and can radiate radio frequency energy and, if not installed and used in accordance with the instruction manual, may cause harmful interference to radio communications. Operation of this equipment in a residential area is likely to cause harmful interference in which case the user will be required to correct the interference at his own expense.

Contents

1 Product Overview	1
2 Structure and Interface	3
2.1 Front Panel	3
2.2 Top Panel.....	5
2.2.1 Low voltage (L1/L3) products Top Panel	5
2.2.2 High voltage (HV) products Top Panel	5
3 Mounting.....	6
3.1 Dimension Drawing.....	6
3.2 Mounting Modes and Steps	6
3.2.1 DIN-Rail Mounting	7
4 Connection	9
4.1 10/100/1000Base-T(X) Ethernet Port.....	9
4.2 1000Base-X, 10/100/1000Base-T(X) SFP slot.....	10
4.2.1 Gigabit SFP Optical Module	11
4.2.2 Gigabit SFP Electrical Module.....	12
4.3 10GBase-X SFP+ port	12
4.4 Console Port	13
4.5 Grounding	14
4.6 Power Terminal Block	15
4.7 Alarm Terminal Block	17
5 Reset	19
6 LEDs.....	20
7 Switch Access	22
7.1 Access through Console Port.....	22
7.2 Access through Telnet	24
7.3 Access through Web	25
8 Basic Features and Specifications.....	26

1 Product Overview

SICOM6416G/SICOM3416G series switch industrial Ethernet switch developed by Kyland for smart coal, petroleum and petrochemical, factory automation, intelligent transportation, rail transit and other industries.

This series of switches supports DIN rail mounting, provides RJ45 management port, supports Console、Telnet、Web management; The switch can be configured with up to four 10GBase-X SFP+, eight 100/1000Base-X,SFP slots (Gigabit SFP interface) and four 10/100/1000Base-T(X) Ethernet interfaces, or four 10GBase-X SFP+, Four 100/1000Base-X,SFP slots (Gigabit SFP interface) and eight 10/100/1000Base-T(X) Ethernet interfaces. The SPF slots support the optical power detection function. The specific configuration is as follows.

Table 1 SICOM6416G/SICOM3416G Models

Model	SICOM6416G - PORT-PS1-PS2 SICOM3416G - PORT-PS1-PS2
Code definition	Code option
Ports	4X8GX4GE, 4X4GX8GE
	Note: 4X8GX4GE <i>four 10GBase-X SFP+;eight 100/1000Base-X, 10/100/1000Base-T(X) SFPslots; four 10/100/1000Base-T(X)ports</i> 4X4GX8GE: <i>four 10GBase-X SFP+;four 100/1000Base-X, 10/100/1000Base-T(X) SFPslots; eight 10/100/1000Base-T(X)ports</i>
PS1-PS2: power input	L1-L1 (48VDC, redundant power input) L3-L3 (24VDC, redundant power input) HV: 100-240VAC,50/60Hz;110-220VDC (Single power input)

**Note:**

We reserve the right to amend the product information listed in this table without notice. To obtain the latest information, you can contact our sales or technical support personnel.

2 Structure and Interface



Caution:

It is recommended to purchase the port dustproof shield (optional) to keep ports clean and ensure switch performance.

2.1 Front Panel

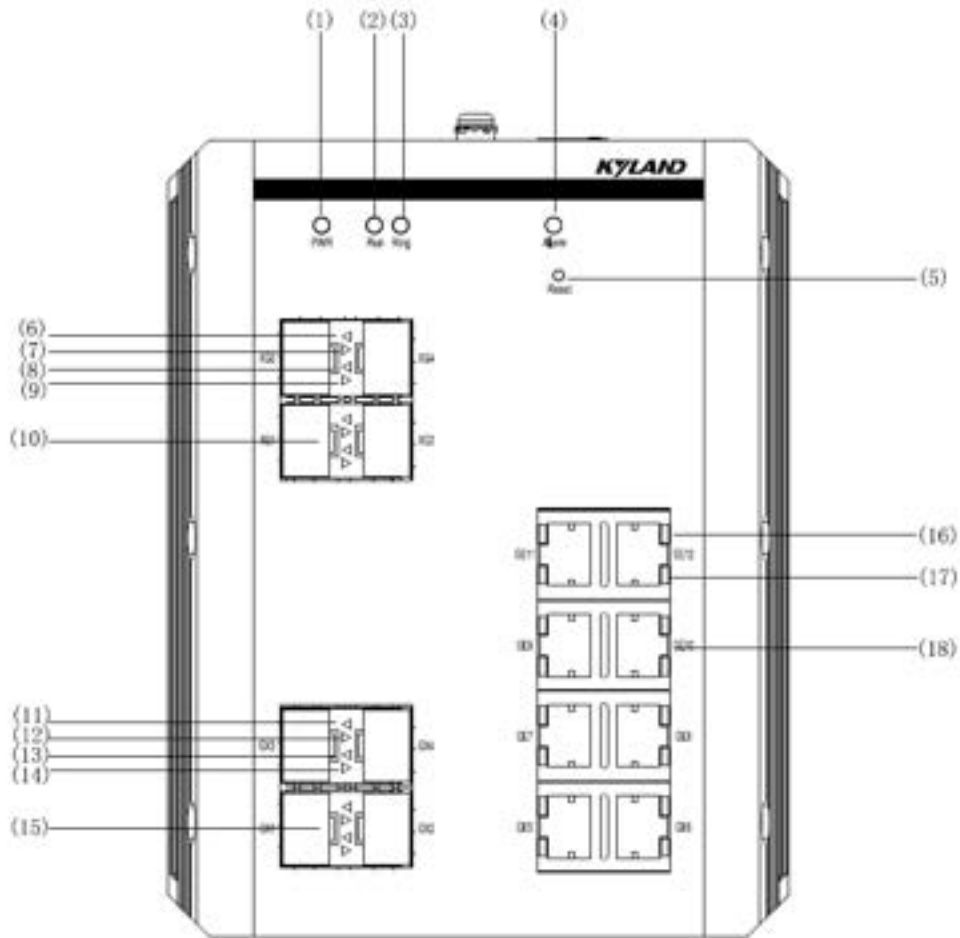

Figure 1 Front Panel

- | | | |
|---|------------------|---|
| (1) Power LED | (2) Running LED | (3) Ring LED |
| (4) Alarm LED | (5) Reset button | (6) 10GBase-X SFP+ Ethernet Port speed LED (yellow) |
| (7) 10GBase-X SFP+ port connection status LED (green) | | (8) 10GBase-X SFP+ Ethernet Port speed LED (yellow) |

(9) 10GBase-X SFP+ port connection status LED
(green)

(11) 100/1000M SFP ethernet Port speed LED
(yellow)

(13) 100/1000M SFP ethernet Port speed LED
(yellow)

(15) 100/1000M SFP

(17) 10/100Base-T(X) port connection status LED
(green)

(10) 10GBase-X SFP+

(12) 100/1000M SFP port connection
status LED (green)

(14) 100/1000M SFP port connection
status LED (green)

(16) 10/100Base-T(X) ethernet Port speed
LED (yellow)

(18) 10/100Base-T(X) Ethernet Port

2.2 Top Panel

2.2.1 Low voltage (L1/L3) products Top Panel

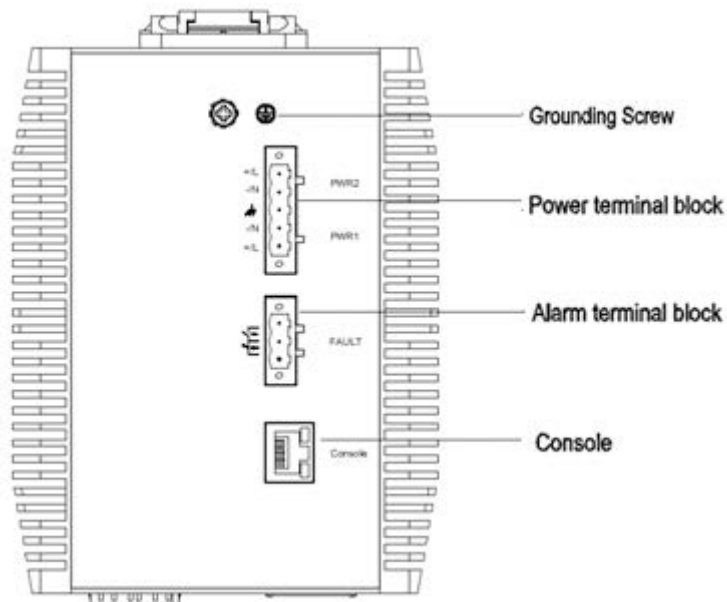

Figure 2 Low voltage products Top Panel

2.2.2 High voltage (HV) products Top Panel

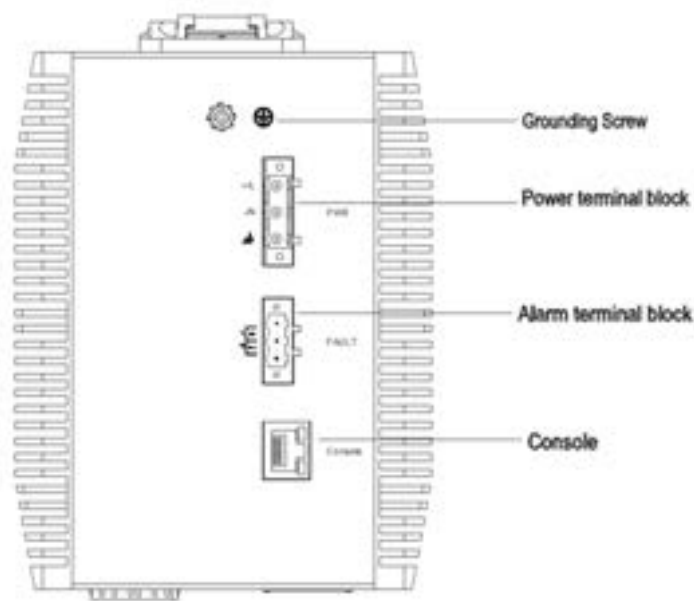

Figure 3 High voltage products Top Panel

3 Mounting

3.1 Dimension Drawing

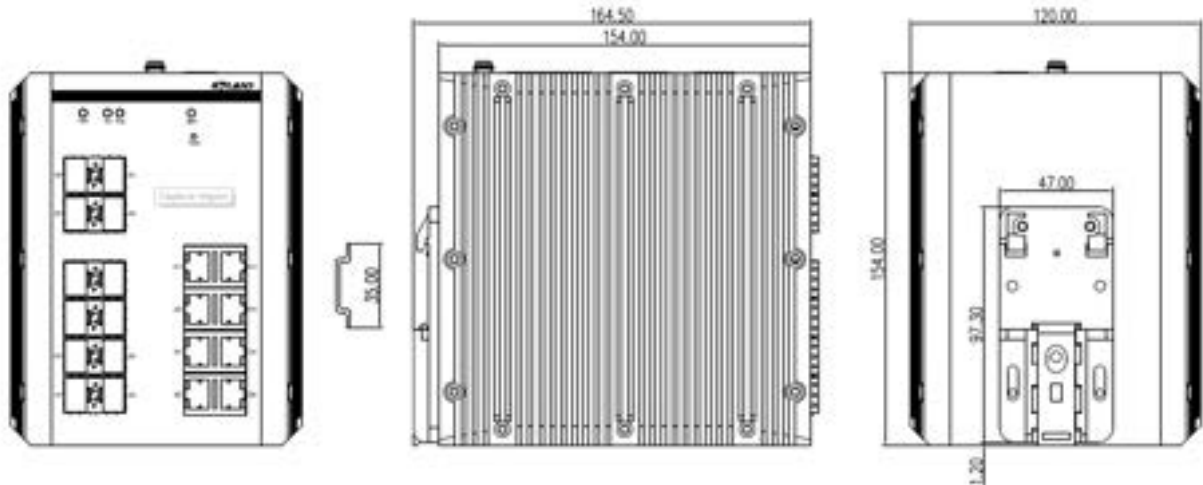

Figure 4 Dimensions for DIN-Rail Mounting (unit: mm)



Caution:

- As part of the heat dissipation system, the switch housing becomes hot during operation. Please use caution when coming in contact and avoid covering the switch housing when the switch is running.
- The figures in this manual are only for reference.

3.2 Mounting Modes and Steps

The device supports both DIN-rail mounting and panel mounting. Before installation, make sure that the following requirements are met.

- 1) Environment: temperature (-40°C to 75°C), ambient relative humidity (5% to 95%, non-condensing)
- 2) Power requirement: The power input is within the voltage range of the switch.
- 3) Grounding resistance: <math><5\Omega</math>
- 4) No direct sunlight, distant from heat source and areas with strong electromagnetic interference.
- 5) Devices are to be installed in an authority certified enclosure and accessible only by the

use of a tool.

6) Devices should be installed and accessed by service personnel or users who have been instructed about the reasons for the restrictions applied to the location and about any precautions that shall be taken.

3.2.1 DIN-Rail Mounting

- DIN-Rail Mounting

Step 1: Select the mounting position for the device and guarantee adequate space and heat dissipation.

Step 2: Insert the connecting seat onto the top of the DIN rail, and push the bottom of the device inward and upward to ensure the DIN rail fits in the connecting seat. Make sure the device is firmly installed on the DIN rail, as shown in the following figure.

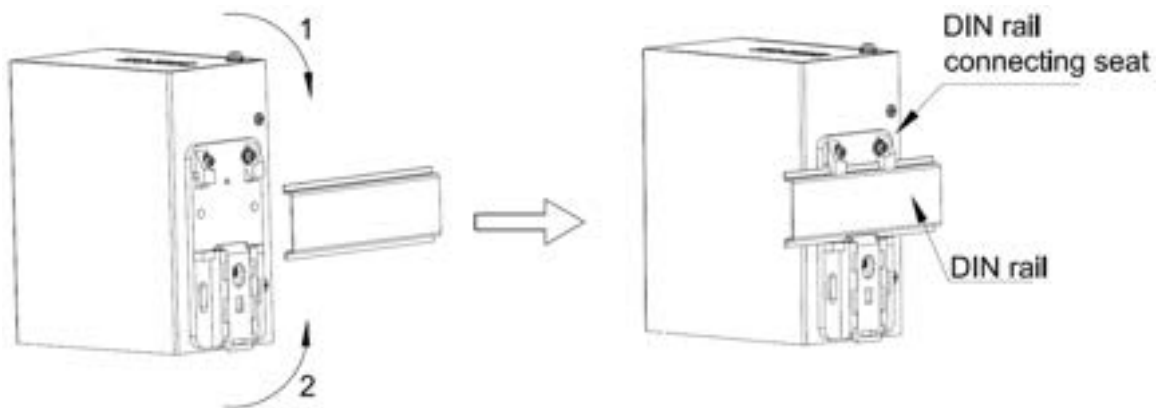

Figure 5 DIN-Rail 2 Mounting

- DIN-Rail Dismounting

Step 1: Insert the head of a screwdriver into the opening of the spring locking piece at the bottom from the left. Lift the handle of the screwdriver to open the spring locking piece of the connecting seat, as shown on the left of the following figure.

Step 2: Move the device in direction 2 until the bottom of the device is detached from the DIN rail. Then move the device in direction 3 and uplift the device until the top of the connecting seat is detached from the DIN rail. In this way, the device is removed from the DIN rail completely.

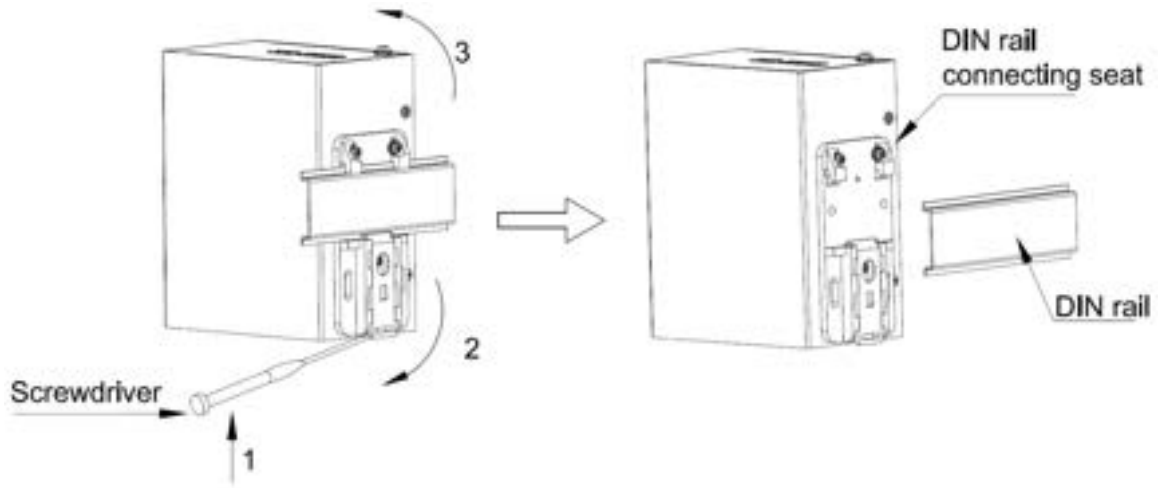

Figure 6 DIN-Rail 2 Dismounting

4 Connection

4.1 10/100/1000Base-T(X) Ethernet Port

10/100/1000Base-T(X) Ethernet port is equipped with RJ45 connector. The port is self-adaptive. It can automatically configure itself to work in 10M, 100M, or 1000M state, full or half duplex mode. The port can also adapt to MDI or MDI-X connection automatically. You can connect the port to a terminal or network device with a straight-through or cross-over cable.

- Pin Definition

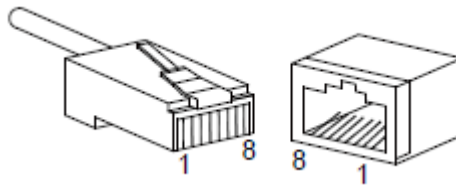



Figure 7 RJ45 Port

Table 2 Pin Definitions of 10/100/1000Base-T(X) RJ45 Port

Pin	MDI-X	MDI
1	Transmit/Receive Data (TRD1+)	Transmit/Receive Data (TRD0+)
2	Transmit/Receive Data (TRD1-)	Transmit/Receive Data (TRD0-)
3	Transmit/Receive Data (TRD0+)	Transmit/Receive Data (TRD1+)
4	Transmit/Receive Data (TRD3+)	Transmit/Receive Data (TRD2+)
5	Transmit/Receive Data (TRD3-)	Transmit/Receive Data (TRD2-)
6	Transmit/Receive Data (TRD0-)	Transmit/Receive Data (TRD1-)
7	Transmit/Receive Data (TRD2+)	Transmit/Receive Data (TRD3+)
8	Transmit/Receive Data (TRD2-)	Transmit/Receive Data (TRD3-)



Note: "+" and "-" indicate level polarities.

- Wiring Sequence

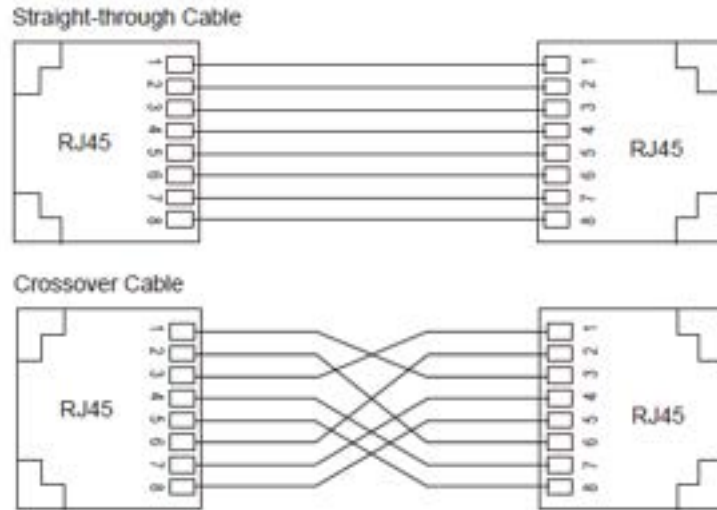

Figure 8 Connection Using Straight-through/Cross-over Cable



Note:

The color of the cable for RJ45 connector meets the 568B standard: 1-orange and white, 2-orange, 3-green and white, 4-blue, 5-blue and white, 6-green, 7-brown and white, and 8-brown.

4.2 1000Base-X, 10/100/1000Base-T(X) SFP slot

1000Base-X, 10/100/1000Base-T(X) SFP slot (gigabit SFP slot) requires an SFP optical/electrical module to enable data transmission. The following table lists the gigabit SFP optical/electrical modules (optional) supported by the series switches.

Table 3 Gigabit SFP Optical/Electrical Modules

Model	Port	MM/SM	Connector	Central Wavelength	Transmission Distance
IGSFP-M-SX-LC-850-0.55	1000Base-X port	MM	LC	850nm	0.55km
IGSFP-S-LX-LC-1310-10	1000Base-X port	SM	LC	1310nm	10km
IGSFP-S-LH-LC-1310-40	1000Base-X port	SM	LC	1310nm	40km
IGSFP-S-ZX-LC-1550-80	1000Base-X port	SM	LC	1550nm	80km

4.2.1 Gigabit SFP Optical Module

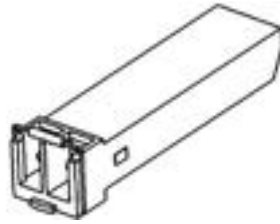

Figure 9 Gigabit SFP Optical Module

An SFP optical module is equipped with LC connector, and each port consists of a TX (transmit) port and an RX (receive) port. To enable communication between Device A and Device B, connect the TX port of Device A to the RX port of Device B, and the RX port of Device A to the TX port of Device B, as shown in the following figure.



Figure 10 Fiber Connection of an SFP Optical Module

- How to Connect the SFP Optical Module

Insert the SFP optical module into the SFP slot in the switch, and then insert the fibers into the TX port and RX port of the SFP module.

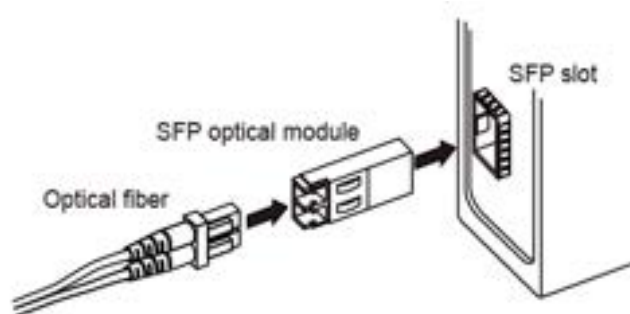

Figure 11 Connecting the SFP Optical Module

Identify the RX port and TX port of an SFP optical module:

1. Insert the two connectors in one end of two fibers into the SFP module, and those in the other end into the peer module.
2. View the corresponding connection status LED:

If the LED is on, the connection is correct. If the LED is off, the link is not connected. This may be caused by incorrect connection of the TX and RX ports. In this case, swap the two connectors at one end of the fibers.



Caution:

- The device uses laser to transmit signals in fibers. The laser meets the requirements of level 1 laser products. Routine operation is not harmful to your eyes, but do not look directly at the fiber port when the device is powered on.
- If the defined transmission distance of an SFP module is longer than 60km, do not use a short fiber (<20km) for connection. If such a short fiber is used, the module will be burned.

4.2.2 Gigabit SFP Electrical Module

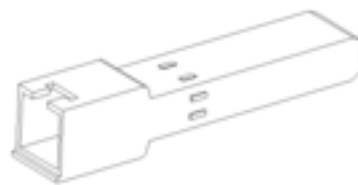

Figure 12 Gigabit SFP Electrical Module

- How to Connect the SFP Electrical Module

Insert the SFP electrical module into the SFP slot in the switch, and then insert the RJ45 connector of the twisted pair into the SFP module.

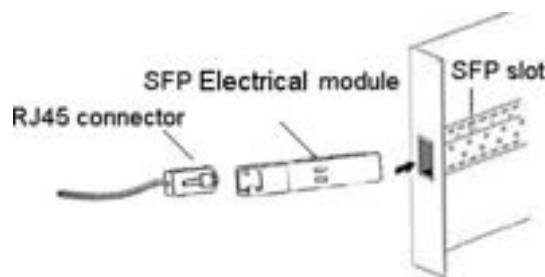

Figure 13 Connecting the SFP Electrical Module

4.3 10GBase-X SFP+ port

10GBase-X SFP+ slot (10GBase-X SFP+ slot) requires an SFP+ optical module to enable data transmission. The following table lists the 10GBase-X SFP+ optical modules (optional) supported by the series switches.

Table 4 SFP+ optical module

Model	Port	MM/SM	Connector	Central Wavelength	Transmission Distance
ATR-S0701DT	10GBase-X	SM	LC	1310nm	10km



Note:

The appearance, wiring and using methods of the 10GBase-X SFP+ port are same as the gigabit SFP slot, user can refer to 4.3

4.4 Console Port

There is a Console port on the front panel of the switch. This console port is an RJ45 interface. You can configure, maintain, and manage the device in two ways.

Way1:

Connect the 9-pin serial port of a PC to the console port of the switch with a DB9-RJ45 console cable. You can configure, maintain, and manage the switch by running Hyper Terminal in the Windows OS of a computer.

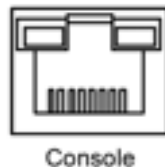

Figure 14 Console Port

- DB9-RJ45 Console Cable

One end of a DB9-RJ45 console cable is the DB9 connector to be inserted into the 9-pin serial port of a PC, and the other end is crimped RJ45 connector to be inserted into the console port of the switch.

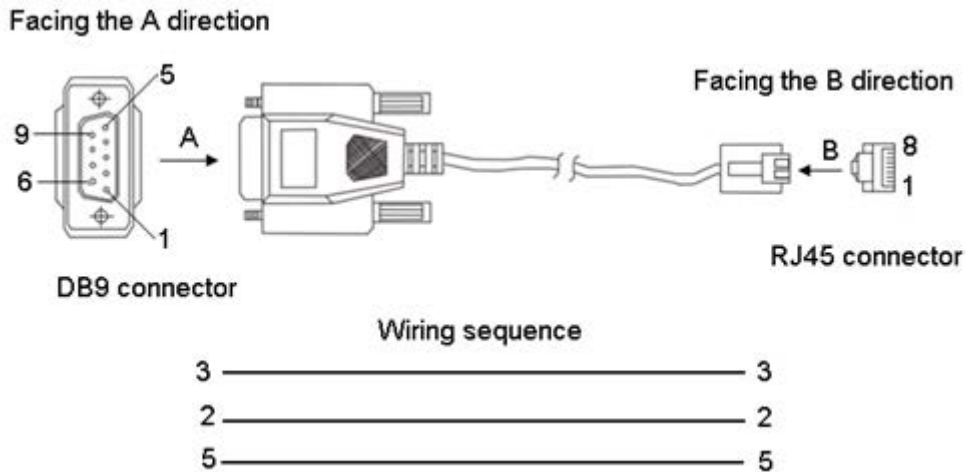

Figure 15 Wiring Sequence of DB9-RJ45 Console Cable

Table 5 Pin Definitions of DB9 Port (9-Pin Serial Port) and RJ45 Port (Console Port)

DB9 Port (9-Pin Serial Port)		RJ45 Port (Console Port)	
Pin	Signal	Pin	Signal
2	RXD (Receive data)	2	TXD (Transmit data)
3	TXD (Transmit data)	3	RXD (Receive data)
5	GND (Grounding)	5	GND (Grounding)

Way2:

Use a standard RJ45 network cable to connect the network port of the PC and the console port of the device, and configure and manage the device through the web.

4.5 Grounding

Grounding protects the device from lightning and interference. Therefore, you must ground the device properly. You need to ground the device before it is powered on and disconnect the grounding cable after the device is powered off.

There is a grounding screw(see figure 2) on the Front panel of the device. The screw is for chassis grounding. After crimping one end of the grounding cable to a cold pressed terminal, secure the end to the grounding screw and firmly connect the other end to ground.



Note:

Cross-sectional area of the chassis grounding cable > 2.5mm²; Grounding resistance < 5Ω

4.6 Power Terminal Block

There is a power terminal block on the Front panel of the switch. You need to connect the power cable to the terminal block to provide power for the switch.

The device supports single (PWR1) and redundant (PWR1 and PWR2) power supply with a 5-pin 5.08mm-spacing plug-in terminal block. When the redundant power supply is used and one power supply is faulty, the switch can continue operating properly, thereby improving network reliability.



Note:

0.75mm² < Cross-sectional area of the power cable < 2.5mm²; Grounding resistance: < 5Ω

- 3-Pin 7.62mm-Spacing Plug-in Terminal Block

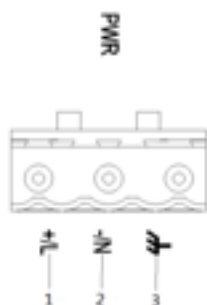

Figure 16 3-Pin 7.62mm-Spacing Plug-in Terminal Block (socket)

Table 6 Pin Definitions of 3-Pin 7.62mm-Spacing Plug-in Terminal Block

端子号	信号名	直流接线定义	交流接线定义
1	+/L	PWR: +	PWR: L
2	-/N	PWR: -	PWR: N
3		PGND	PGND

- 5-pin 5.08mm-spacing plug-in terminal block

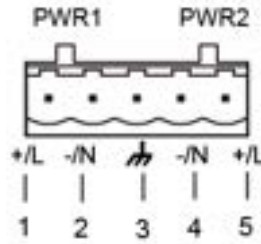

Figure 17 5-Pin 5.08mm-Spacing Plug-in Terminal Block

Table 7 Pin Definitions of 5-Pin 5.08mm-Spacing Plug-in Terminal Block

No.	Signal	DC Definition	AC Definition
1	+/L	PWR1: +	PWR1: L
2	-/N	PWR1: -	PWR1: N
3		PGND	PGND
4	-/N	PWR2: -	PWR2: N
5	+/L	PWR2: +	PWR2: L

● Wiring and mounting

Step 1: Ground the switch properly according to section 4.5.

Step 2: Remove the power terminal block from the switch.

Step 3: Insert the power cable into the power terminal block according to Table 7 to fix the power cable.

Step 4: Insert the terminal with the connected cable into the terminal block on the device.

Step 5: Connect one end of the power cable to an external power supply system (with the allowed power range). If the power LED on the front panel of the switch turns on, the power supply is connected properly.

Wiring and Mounting should meet following specifications.

Table 8 Wiring and Mounting Specifications

Terminal Type	Required Torque	Wire Range (AWG)
Terminal Block Plug	4.5-5.0 lb-in	12-24

Caution:



Before connecting the device to power supply, make sure that the power input meets the power

requirement. If connected to an incorrect power input, the device may be damaged.



Warning:

- Do not touch any exposed conducting wire, terminal, or component with a voltage warning sign, because it may cause personal injury.
- Do not remove any part or plug in or out any connector when the device is powered on.

4.7 Alarm Terminal Block

The alarm terminal block is used for alarm output. When the switch works properly, the normally-open contacts of the alarm relay are closed and the normally-closed contacts are open. When an alarm occurs, the normally-open contacts are open and the normally-closed contacts are closed. The alarm is outputted through a 3-pin 5.08mm spacing terminal block, as shown in Figure 18.

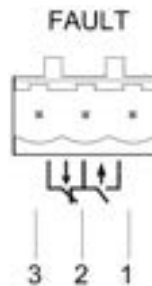

Figure 18 Alarm Terminal Block

Electrical parameters of the relay:

Max Switch Voltage: 250VAC/220VDC

Max Switch Current: 2A

Max Switch Power: 60W

Maximum dielectric voltage withstand: 2KV



Note:

Pin 1 and pin 2 are normally-open contacts; pin 2 and pin 3 are normally-closed contacts. When the switch works properly, pin 1 and pin 2 are closed, pin 2 and pin 3 are open; when an alarm occurs, pin 1 and pin 2 are open; pin 2 and pin 3 are closed.

- Wiring and Mounting

Step 1: Remove the alarm terminal block from the switch.

Step 2: Secure the three wires for alarm into the alarm terminal block in the required sequence.

Step 3: Insert the alarm terminal block into its socket.

Wiring and Mounting should meet following specifications.

Table 9 Wiring and Mounting Specifications

Terminal Type	Required Torque	Wire Range (AWG)
Terminal Block Plug	4.5-5.0 lb-in	12-24

5 Reset

The device provides a Reset button on the front panel. The button can be used to restart the device or restore factory default settings.

You can restart the device by pressing and holding the button for 0.5 to 3 second.

You can restore factory default settings by pressing and holding the button for 3 seconds or more.

**Caution:**

To restart the device only, do not press and hold the button for 3 seconds or more, because the operation will restore factory default settings.

6 LEDs

Table 10 Front Panel LEDs

LED	State	Description
Power 1 LED-PWR1	On	The power 1 is connected and operates properly.
	Off	The power 1 is not connected or operates abnormally.
Power 2 LED-PWR2	On	The power 2 is connected and operates properly.
	Off	The power 2 is not connected or operates abnormally.
Running LED-Run	Blinking	The CPU operates properly.
	On	The CPU is starting up.
	Off	The CPU does not start up.
Ring LED	On	Master (DT-Ring mode)/Root (DRP mode)
	Blinking	Slave (DT-Ring mode)/B-Root or Normal (DRP mode)
	Off	No ring
Alarm LED-Alarm	On	An alarm occurs.
	Off	No alarm occurs.
10GBase-X SFP+ slot connection status LED (yellow)	On	10G working state (10G Base-X)
	Off	1000M working state (1000Base-TX) or no connection
1000Base-T(X) , 10/100/1000Base-T(X) SFP slot connection status LED (yellow)	On	1000M working state (1000Base-TX)
	Off	100M working state (100Base-TX) or no connection
10GBase-X SFP+, 1000Base-X, 10/100/1000Base-	On	Effective port connection
	Blinking	Ongoing network activities

T(X)SFP Ethernet port connection status LED (green)	Off	No effective port connection
10/100Base-T(X) Ethernet port speed LED (yellow)	On	1000M working state (1000Base-T (X))
	Off	10M or 100M working state or no connection
10/100Base-T(X) Ethernet port connection status LED (green)	On	Effective port connection
	Blinking	Ongoing network activities
	Off	No effective port connection

7 Switch Access

You can access the switch in any of the following ways:

7.1 Access through Console Port

The console port is an RJ45 interface, and you can access the device in two ways.

- DB9-RJ45 console cable

Step 1: Connect the console port of the switch to the 9-pin serial port of a PC with the delivered DB9-RJ45 console cable.

Step 2: Open the Hyper Terminal in the Windows OS. On the desktop, click Start → All Programs → Accessories → Communications → Hyper Terminal.

Step 3: Create a connection "Switch", as shown in Figure 19.



Figure 19 Creating a Connection

Step 4: Connect the communication port in use, as shown in Figure 20.



Figure 20 Selecting the Communication Port in Use



Note:

To confirm the communication port in use, right-click [My Computer] and click [Property]→[Hardware]→[Device Manager]→[Port] to view the communication port.

Step 5: Set port parameters (Bits per second: 115200, Data bits: 8, Parity: None, Stop bits: 1, and Flow control: None), as shown in Figure 21.



Figure 21 Setting Port Parameters

Step 6: Click OK to enter the switch CLI. Then you can run the following commands to perform operations.

Table 11 CLI Commands

View	Command	Description
User view	SWITCH>enable	Enter the management view.
Management view	SWITCH#show interface	Query the IP address of the switch.
Management view	SWITCH#show version	Query the version of the switch.
Management view	SWITCH#reboot	Restart the switch.
Management view	SWITCH#load default	Restore the factory default settings
Management view	SWITCH#config terminal	Enter the configuration view.

- RJ45 console cable

1. The PC and the switch can communicate normally;
2. Input "*IP address*" in the browser address bar (Default ip: 192.168.1.2). After opening the login dialog box, enter the default user name (admin) and default password (123) to successfully log in to the device Web management page.

7.2 Access through Telnet

Step 1: Connect the network port of a PC to the Ethernet port of the switch with a network cable.

Step 2: Enter "telnet IP-address" in the Run dialog box, as shown in Figure 22. The default IP address of a Kyland switch is 192.168.0.2.

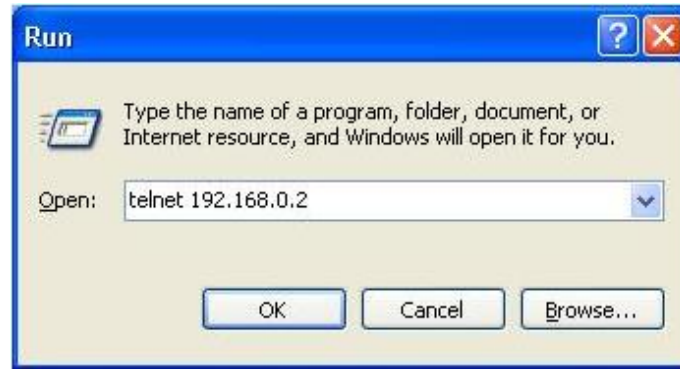

Figure 22 Access through Telnet

Step 3: Click OK. The Telnet CLI is displayed. Then you can enter commands (as shown in Table 11) to perform operations.

7.3 Access through Web

Step 1: Connect the network port of a PC to the Ethernet port of the switch with a network cable.

Step 2: Enter the IP address of the switch in the address box of the browser. The user login interface is displayed. You can log in to the Web UI by default user name "admin" and password "123".



Note:

- IE8.0 or a later version is recommended.
- For details about how to access the switch and other operation, refer to the Web operation manual in the delivered CD.

8 Basic Features and Specifications

Power Requirements

Power Identifier	Rated Voltage Range	Maximum Voltage Range
L1	48VDC	36-72VDC
L3	24VDC	18-36VDC
HV	100-240VAC,50/60Hz;110-220VDC	85-264VAC/77-300VDC
Terminal block	L1/L3: 5-pin 5.08 mm-spacing plug-in terminal block HV: 3-pin 7.62 mm-spacing plug-in terminal block	

Rated Power Consumption

Rated Power Consumption	SICOM6416G/SICOM3416G-L3-L3 23W
-------------------------	---

Physical Characteristics

Housing	Metal, fanless
Protection class	IP40
Installation	DIN-rail mounting
Dimensions(WxHxD)	120mm×154mm×164.5mm (Including the power supply protruding from the casing surface)
Weight:	1.1KG

Environmental Limits

Ambient temperature	-40℃ ~ +75℃
Storage temperature	-40℃ ~ +85℃
Ambient relative humidity	5% ~ 95% (non-condensing)

Warranty

Warranty	Five years
----------	------------

KYLAND

FAX: +86-10-88796678

Website: <http://www.kyland.com>

Email: support@kyland.com

For more information about KYLAND
products, please visit our website:

<http://www.kyland.com>