

TimeServer Module

Hardware Installation Manual

Publication Data: Oct. 2016

Version: V1.0

No.:

KYLAND

TimeServer Module

Hardware Installation Manual

Disclaimer: Kyland Technology Co., Ltd. tries to keep the content of this manual as accurate and as updated as possible. This document is not guaranteed to be error-free, and we reserve the right to amend it without notice to users.

All rights reserved.

No part of this documentation may be excerpted, reproduced, translated, annotated or duplicated, in any form or by any means without the prior written permission of KYLAND Corporation.

Copyright © 2016 Kyland Technology Co., Ltd.

Notice for Safety Operation

The product performs reliably as long as it is used according to the guidance. Artificial damage or destruction of the device should be avoided. Before using the device, read this manual carefully for personal and equipment safety. Please keep the manual for further reference. Kyland is not liable to any personal or equipment damage caused by violation of this notice.

- Do not place the device near water sources or damp areas. Keep the ambient relative humidity within the range from 5% to 95% (non-condensing).
- Do not place the device in an environment with high magnetic field, strong shock, or high temperature. Keep the working and storage temperatures within the allowed range.
- Install and place the device securely and firmly.
- Please keep the device clean; if necessary, wipe it with a soft cotton cloth.
- Do not place any irrelevant materials on the device or cables. Ensure adequate heat dissipation and tidy cable layout without knots.
- Wear antistatic gloves or take other protective measures when operating the device.
- Avoid any exposed metal wires because they may be oxidized or electrified.
- Install the device in accordance with related national and local regulations.
- Before power-on, make sure the power supply is within the allowed range of the device. High voltage may damage the device.
- Power connectors and other connectors should be firmly interconnected.
- Do not plug in or out the power supply with wet hands. When the device is powered on, do not touch the device or any parts with wet hands.
- Before operating a device connected to a power cable, remove all jewelry (such as rings, bracelets, watches, and necklaces) or any other metal objects, because they may cause electric shock or burns.
- Do not operate the device or connect or disconnect cables during an electrical storm.
- Use compatible connectors and cables. If you are not sure, contact our sales or technical support personnel for confirmation.

- Do not disassemble the device by yourself. When an anomaly occurs, contact our sales or technical support personnel.
- If any part is lost, contact our sales or technical support personnel to purchase the substitute. Do not purchase parts from other channels.
- Dispose of the device in accordance with relevant national provisions, preventing environmental pollution.
- Specification of the internal fuses in this equipment: 3.15A/300V.

In the following cases, please immediately shut down your power supply and contact your Kyland representative:

- Water gets into the equipment.
- Equipment damage or shell damage.
- Equipment operation or performance has abnormally changed.
- The equipment emits odor, smoke or abnormal noise.

Contents

1 Product Overview	1
2 Structure and Interface	2
2.1 Front Panel	2
2.2 Output Signal	3
3 Installation	4
3.1 Dimension Drawing	4
3.2 Mounting Modes and Steps	5
3.2.1 Installing Mounting Brackets.....	5
3.2.2 Insert the module into the 1U slot.....	5
3.3 Dismounting Modes and Steps	6
4 Connection	8
4.1 Satellite Signal Input Port.....	8
4.1.1 Installing Satellite Antenna	8
4.2 Optical Signal Input.....	12
4.3 TTL Signal Output.....	12
4.4 RS485 signal output.....	13
4.5 Optical signal output.....	14
4.6 10/100/1000Base-T(X) Ethernet Port.....	14
4.7 1000Base-X, 100Base-FX SFP slot.....	15
4.7.1 SFP Optical Module.....	16
4.8 Console Port	17
5 LEDs.....	19
6 Access	20
6.1 Access through Web	20
7 Basic Features and Specifications.....	21

1 Product Overview

TimeServer Module is designed for the SICOM3028GPT switch to support time synchronization inside. It can make switch have master clock function inside to service for whole network and applications.

TimeServer Module supports high precision reference clock, which can be synchronized to absolute time such as GPS, BDS, and GLONASS etc. Built-in OXCO help to provide stable reference frequency source. System supports multiple sources time sync auto selection algorithm which can perform stable switch between GPS, BDS, GLONASS, IRIG-B, PTP and local clock, and sky/ground and master/slave clock backup.

TimeServer Module provides flexible time output channels and signals. The output timing signals include PPS, IRIG-B (Demodulated) etc. Plus, TimeServer Module supports network sync time protocols NTP/SNTP and PTP (IEEE1588 v2) that can works in several modes by the software configuration including grandmaster clock, slave clock and boundary clock.

TimeServer Module supports TMS function inside to send time status and clock status to control center by IEC61850 MMS, IEC60870-5-104, DNP3.0 over TCP, Modbus TCP etc. Meanwhile, it also provides GOOSE subscriber and GOOSE publisher function inside to implement time management function.

TimeServer Module supports SNMP and WEB management. Any web browser can access TimeServer Module.

2 Structure and Interface



Caution:

It is recommended to purchase the port dustproof shield (optional) to keep ports clean and ensure device performance.

2.1 Front Panel

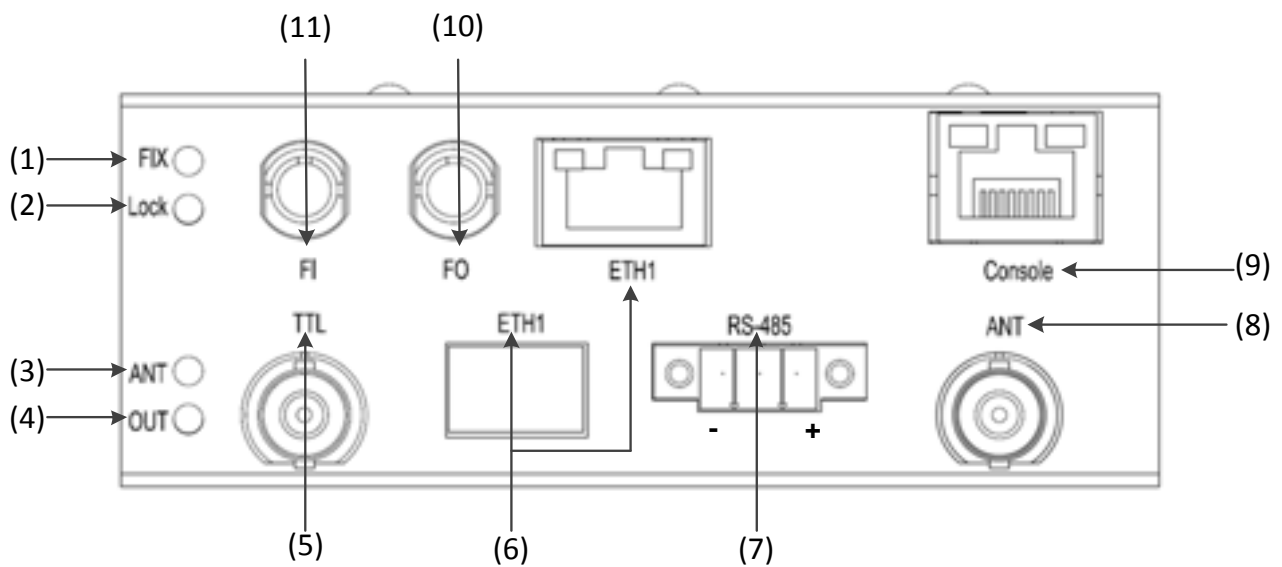

Figure 1 Front Panel

Table 1 Description of the Front Panel

No.	Identifier	Description
1	FIX	Position Satellite LED.
2	Lock	Frequency Lock LED.
3	ANT	Satellite Antenna Status LED
4	OUT	Output Signal LED
5	TTL	BNC, support IRIG-B, PPS output signal.
6	ETH1	SFP (Fiber) or RJ45 (copper) combo network, support 100/1000M.
7	RS-485	Terminal, support IRIG-B, PPS output signal.

8	ANT	BNC, support GPS/BDS/GLONASS satellite signal as time source.
9	Console	RJ45, RS232 mode, 115200-8-N-1, console port.
10	FO	ST, 850nm, 1310nm (Optional), support IRIG-B, PPS output signal.
11	FI	ST, 850nm, 1310nm (Optional), support IRIG-B input signal.

2.2 Output Signal

TimeServer Module supports more programmable output channel to control each output interface. The programmable channels are O2/O3/O4. The default output will be shown as:

Table 2 TimeServer Output Specification

No	Name	Panel	Default Output	Optional Output
1	O2	FO	IRIG-B	IRIG-B/PPS
2	O3	RS-485	IRIG-B	IRIG-B/PPS
3	O4	TTL	IRIG-B	IRIG-B/PPS

3 Installation

3.1 Dimension Drawing

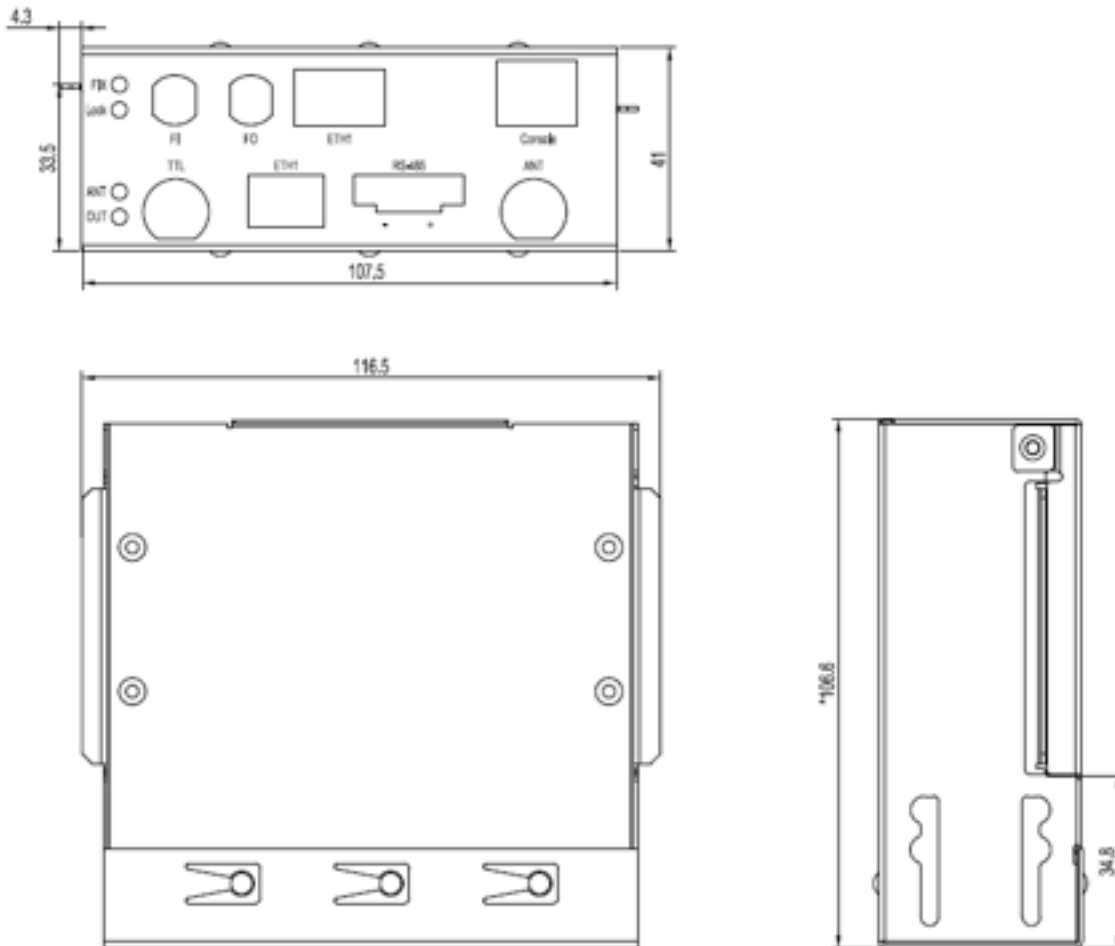

Figure 2 Dimensions (unit: mm)



Caution:

- As part of the heat dissipation system, the switch housing becomes hot during operation. Please use caution when coming in contact and avoid covering the switch housing when the switch is running.
- The figures in this manual are only for reference.

3.2 Mounting Modes and Steps

SICOM3028GPT series switches provide six 0.5 slots on the rear panel, each TimeServer module occupies two 0.5U slots.



Caution:

Power off the switch before you install or remove an interface module.

3.2.1 Installing Mounting Brackets

Before inserting the TimeServer module into the slot of the Switch, install mounting brackets on the module as follows:

Insert four mounting brackets into the screw holes at both sides of the module. Push the brackets in direction 1 until the brackets are firmly secured to the module.

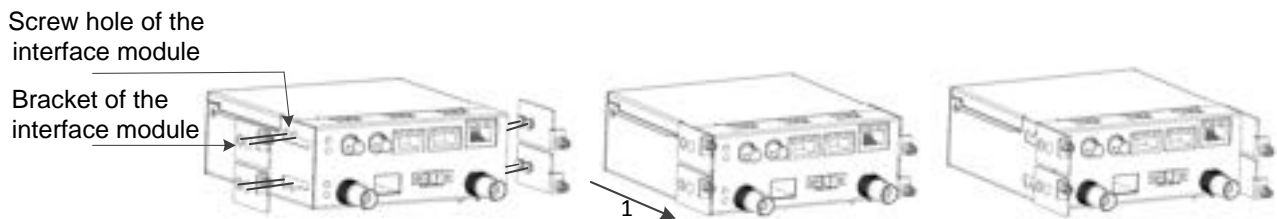

Figure 3 Installing Mounting Brackets

3.2.2 Insert the module into the rear panel slot of the Switch

Step 1: Insert the guide rail of the interface module into the guide rail slot with "TOP" facing up. Then push the module into the slot along the guide rail slot until it is in position.

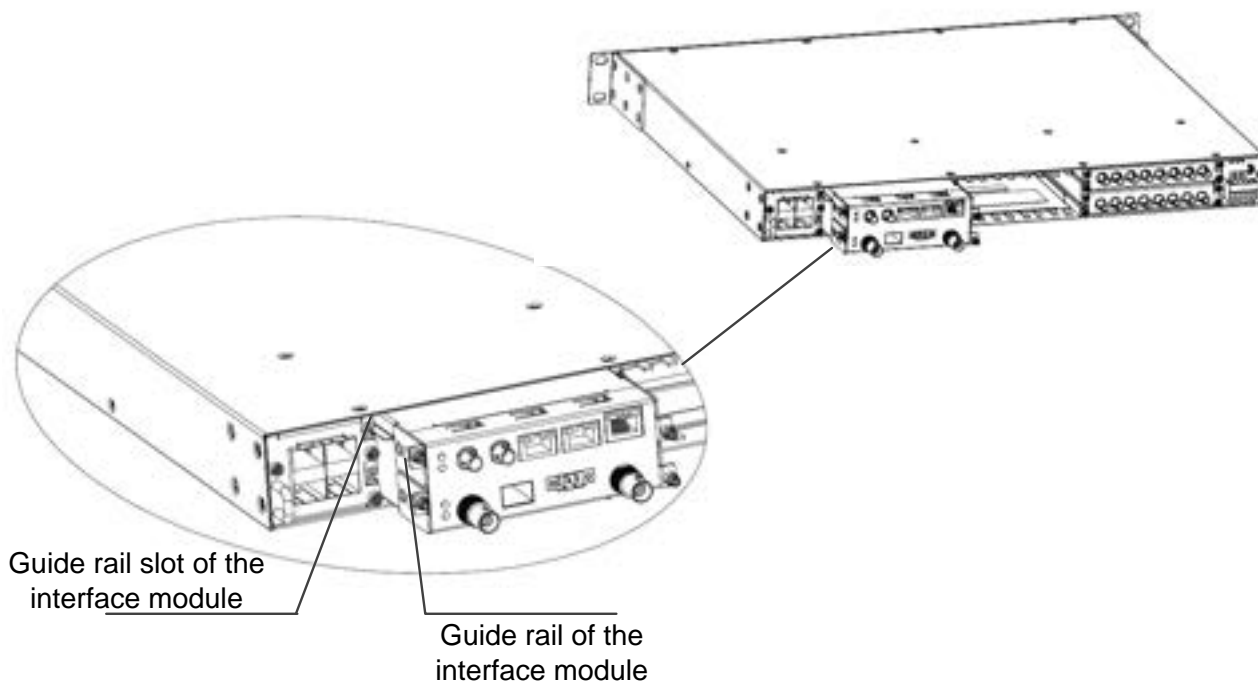

Figure 4 Insert the module into the rear panel slot of the Switch



Caution:

- To insert the module into the rear panel slot of the Switch, keep the "TOP" identifier on the module facing up.
- If the module cannot be pushed into place, do not force it, because too much force may cause damage to the module. In this case, remove the module and check the guide rail slot for any foreign materials or deformation. If the fault cannot be rectified, contact our sales or technical support personnel

Step 2: Push the mounting brackets into the slot completely. Insert four captive screws (M3×15) into the screw holes of the switch to secure the interface module to the switch.

3.3 Dismounting Modes and Steps

Detailed steps are as follows:

Step 1: Remove the four screws securing the module to the switch.

Step 2: Pull out the mounting brackets.

Step 3: Remove the module from the switch by holding the brackets.

Step 4: Remove the brackets from the module, as shown in the following figure.

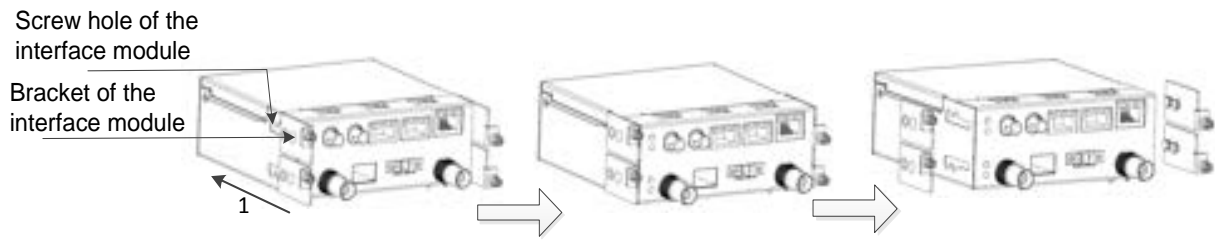

Figure 5 Removing Mounting Brackets

4 Connection

4.1 Satellite Signal Input Port

Satellite signal input port can be used to connect and supply power for Satellite antenna that can receive satellite signal; the supplied power voltage is 5VDC. The port is assembled with BNC connector as shown in Figure 6.



Figure 6 Satellite Signal Input Port

4.1.1 Installing Satellite Antenna

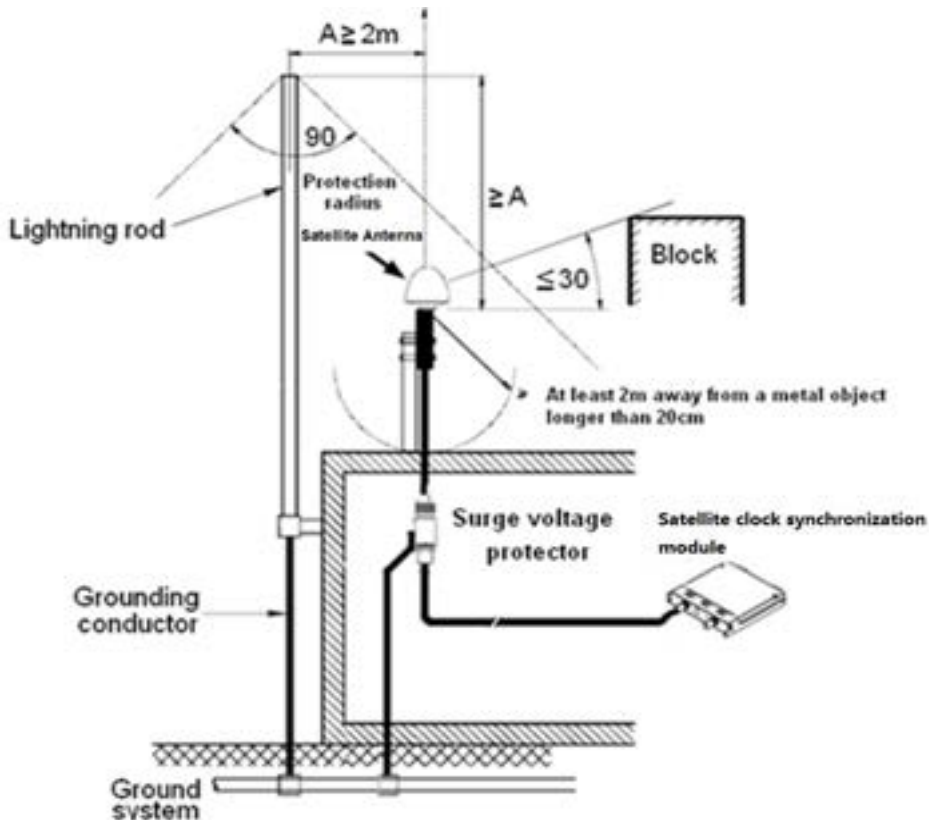

Figure 7 Installing Satellite Antenna

- Installation position

1. Lower than the top of the lightning rod

To be protected by the lightning rod, the Satellite antenna should be positioned lower than the top of the lightning rod.

2. Unshielded view of the sky

The Satellite antenna should be positioned with a clear view of the sky. The biggest obstacle in the surrounding should not block a horizontal section larger than 30 degrees, that is, the vertical upward view without a block should be larger than 120 degrees, as shown in Figure 7 .

3. Free from interference

To prevent interference caused by reflected wave, the Satellite antenna should be positioned at least 2m away from a metal object longer than 20cm, as shown in Figure 7.

The Satellite antenna should not be installed near another transmitting or receiving device, below a microwave antenna or high-voltage cable, or directly in the radiation direction of another transmitting antenna.

A minimum of 2m distance should be kept between any two Satellite antennas. You are advised to install multiple Satellite antennas in different locations to prevent mutual interference.

- Installation steps

You can choose whether to install the surge voltage protector as needed. Table 3 lists specific installation steps.

Table 3 Satellite Antenna Installation

	Satellite Antenna Installation (without surge voltage protector)	Satellite Antenna Installation (with surge voltage protector)
Step 1: Purchase product	20-meter low-loss RF coaxial cable (DT-XL-LMR400-TNC-BNC-20m)	1. Adapter for low-loss RF coaxial cable (DT-ZJQ-BNC-TNC-01) 2. 20-meter low-loss RF coaxial cable

<p>optional accessories</p>		<p>(DT-XL-LMR400-TNC-BNC-20m)</p> <p>3. 2-meter low-loss RF coaxial cable (DT-XL-LMR400-TNC-BNC-2m)</p> <p>4. Surge voltage protector (DT-SP-01)</p>
<p>Step 2: Connect cables for Satellite antenna</p>	<p>Lead the TNC (male) of the low-loss RF coaxial cable (DT-XL-LMR400-TNC-BNC-20m) through the opening of the antenna bracket. Connect the TNC (male) of the low-loss RF coaxial cable (DT-XL-LMR400-TNC-BNC-20m) to the TNC (female) of the Satellite antenna. Tighten the bracket with the Satellite antenna.</p>	
<p>Step 3: Secure Satellite antenna</p>	<p>Secure the antenna bracket with a bolt at a higher position, for example, the top of a building. Parallel the receiving surface of the Satellite antenna with the ground for optimal signal reception.</p>	
<p>Step 4: Connect Satellite clock synchronization module</p>	<p>Connect the BNC (male) of the low-loss RF coaxial cable (DT-XL-LMR400-TNC-BNC-20m) to the BNC (female) of the Satellite signal input port on the Satellite clock synchronization module.</p>	<ol style="list-style-type: none"> 1. Connect the BNC (male) of the low-loss RF coaxial cable (DT-XL-LMR400-TNC-BNC-20m) to BNC (female) of the adapter for low-loss RF coaxial cable. (DT-ZJQ-BNC-TNC-01) 2. Solder a grounding conductor (cross-sectional area$\geq 4\text{mm}^2$, as short as possible) to the GND of the surge voltage protector. Connect the grounding conductor to the ground system. 3. Connect the TNC (female) of the adapter for low-loss RF coaxial cable

		<p>(DT-ZJQ-BNC-TNC-01) to TNC (male) of the surge voltage protector.</p> <p>4. Connect the low-loss RF coaxial cable (DT-XL-LMR400-TNC-BNC-2m) to the TNC (female) of the surge voltage protector and the BNC (female) of the Satellite signal input port on the Satellite clock synchronization module respectively.</p>
--	--	---

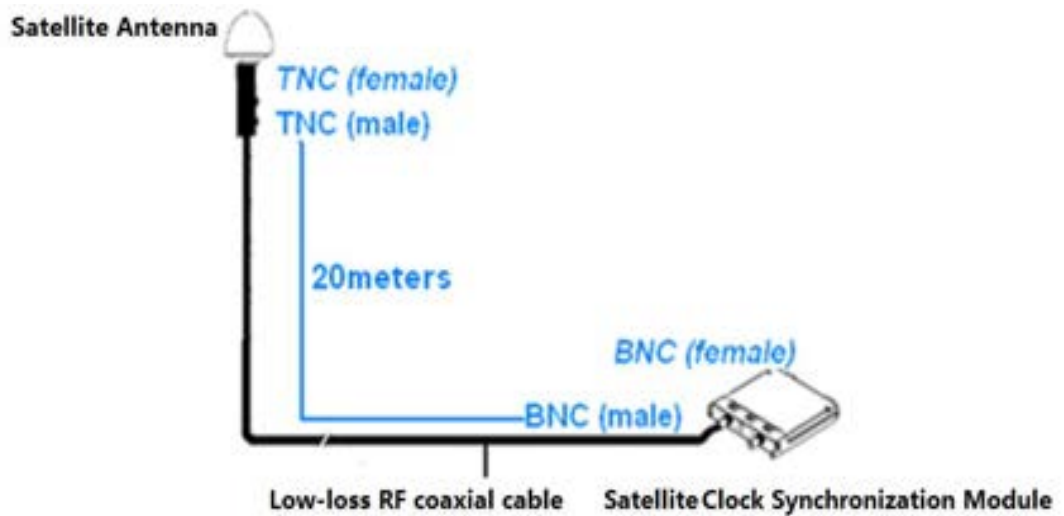

Figure 8 Connecting Satellite Antenna to Satellite Clock Synchronization Module (no surge voltage protector)

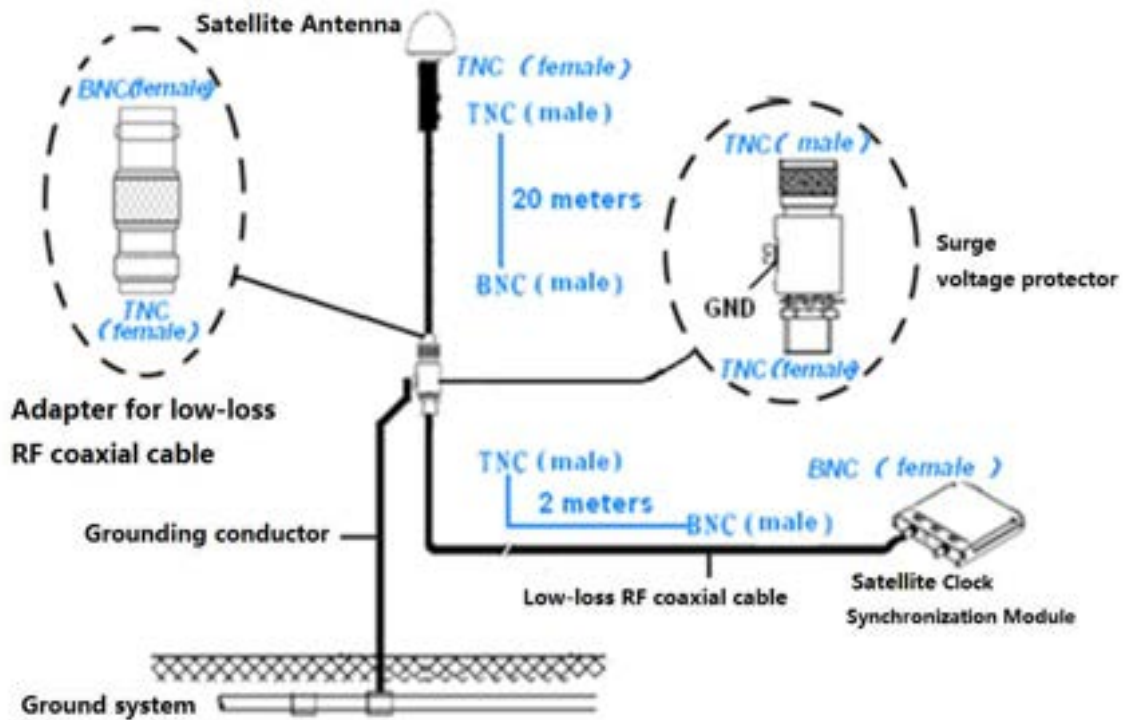

Figure 9 Connecting Satellite Antenna to Satellite Clock Synchronization Module (including surge voltage protector)

Note: It is recommended to install the surge voltage protector indoor. If it is installed outdoor, you must take waterproof measures.

4.2 Optical Signal Input

Optical signal input ST interface, multi-mode 850nm or multi-mode 1310nm, support IRIG-B signal input.



Figure 10 Optical signal input ST interface

4.3 TTL Signal Output

TTL signal output through the BNC connector output, can be configured by software

IRIG-B output or PPS output.

- BNC connector (female)



Figure 11 IRIG-B (DC) BNC Connector (female)

4.4 RS485 signal output

RS485 signal output through the three-pin 3.81mm pitch plug-in terminal output, can be configured by software IRIG-B output or PPS output.

- 3-Pin 3.81mm-spcing plug-in terminal block(Socket)

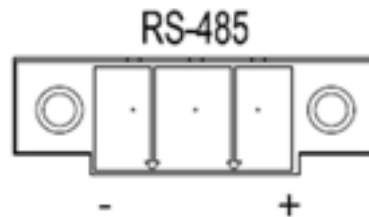

Figure 12 3-Pin 3.81mm-spcing Plug-in Terminal Block (Socket)

Table 4 3-Pin 3.81mm-spcing Plug-in Terminal Block definition

Diagram Label	Description
+	RS485+
-	RS485-



Note:

IRIG-B output, TTL +5V level, trigger by rising edge, port load: 40mA.

4.5 Optical signal output

Optical signal output for the ST interface, multi-mode 850nm or multi-mode 1310nm, can be configured by software IRIG-B output or PPS output.



Figure 13 Optical signal output ST interface

4.6 10/100/1000Base-T(X) Ethernet Port

10/100/1000Base-T(X) Ethernet port is equipped with RJ45 connector. The port is self-adaptive. It can automatically configure itself to work in 10M, 100M, or 1000M state, full or half duplex mode. The port can also adapt to MDI or MDI-X connection automatically. You can connect the port to a terminal or network device with a straight-through or cross-over cable.

- Pin Definition

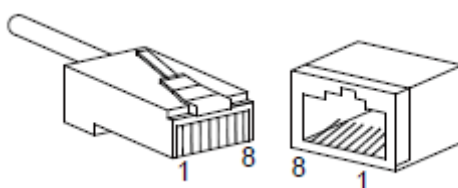

Figure 14 RJ45 Port

Table 5 Pin Definitions of 10/100/1000Base-T(X) RJ45 Port

Pin	MDI-X	MDI
1	Transmit/Receive Data (TRD1+)	Transmit/Receive Data (TRD0+)
2	Transmit/Receive Data (TRD1-)	Transmit/Receive Data (TRD0-)
3	Transmit/Receive Data (TRD0+)	Transmit/Receive Data (TRD1+)

4	Transmit/Receive Data (TRD3+)	Transmit/Receive Data (TRD2+)
5	Transmit/Receive Data (TRD3-)	Transmit/Receive Data (TRD2-)
6	Transmit/Receive Data (TRD0-)	Transmit/Receive Data (TRD1-)
7	Transmit/Receive Data (TRD2+)	Transmit/Receive Data (TRD3+)
8	Transmit/Receive Data (TRD2-)	Transmit/Receive Data (TRD3-)



Note:

"+" and "-" indicate level polarities.

● **Wiring Sequence**

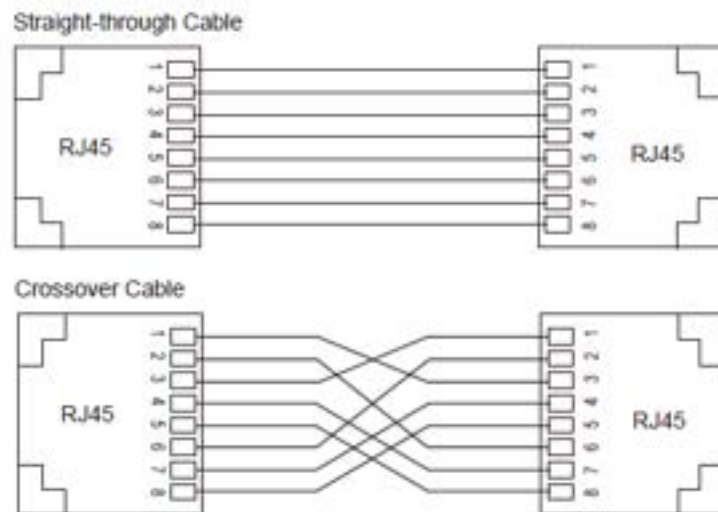

Figure 15 Connection Using Straight-through/Cross-over Cable



Note:

The color of the cable for RJ45 connector meets the 568B standard: 1-orange and white, 2-orange, 3-green and white, 4-blue, 5-blue and white, 6-green, 7-brown and white, and 8-brown.

4.7 1000Base-X, 100Base-FX SFP slot

1000Base-X, 100Base-FX SFP slot requires an SFP optical module to enable data transmission. The following table lists the SFP optical modules (optional) supported by the series switches.

Table 6 SFP Optical Modules

Model	Port	MM/SM	Connector	Central Wavelength	Transmission Distance
IGSFP-M-SX-LC-850-0.55	1000Base-X port	MM	LC	850nm	0.55km
IGSFP-S-LX-LC-1310-10	1000Base-X port	SM	LC	1310nm	10km
IGSFP-S-LH-LC-1310-40	1000Base-X port	SM	LC	1310nm	40km
IFSFP-M-LX-LC-1310-2	100Base-FX port	MM	LC	1310nm	2km
IFSFP-S-LH-LC-1310-40	100Base-FX port	SM	LC	1310nm	40km

4.7.1 SFP Optical Module

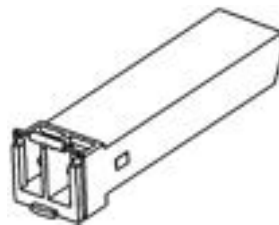

Figure 16 SFP Optical Module

An SFP optical module is equipped with LC connector, and each port consists of a TX (transmit) port and an RX (receive) port. To enable communication between Device A and Device B, connect the TX port of Device A to the RX port of Device B, and the RX port of Device A to the TX port of Device B, as shown in the following figure.



Figure 17 Fiber Connection of an SFP Optical Module

- How to Connect the SFP Optical Module

Insert the SFP optical module into the SFP slot in the switch, and then insert the fibers into the TX port and RX port of the SFP module.

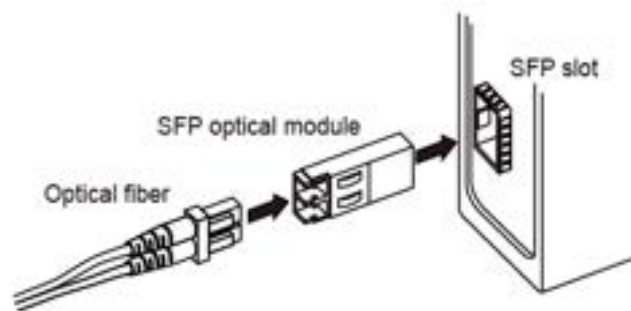

Figure 18 Connecting the SFP Optical Module

Identify the RX port and TX port of an SFP optical module:

1. Insert the two connectors in one end of two fibers into the SFP module, and those in the other end into the peer module.
2. View the corresponding connection status LED:

If the LED is on, the connection is correct. If the LED is off, the link is not connected. This may be caused by incorrect connection of the TX and RX ports. In this case, swap the two connectors at one end of the fibers.



Caution:

- The device uses laser to transmit signals in fibers. The laser meets the requirements of level 1 laser products. Routine operation is not harmful to your eyes, but do not look directly at the fiber port when the device is powered on.
- If the defined transmission distance of an SFP module is longer than 60km, do not use a short fiber (<20km) for connection. If such a short fiber is used, the module will be burned.

4.8 Console Port

There is a console port on the front panel of the module. The RJ45 connector use a DB9-RJ45 console cable to connect the 9-pin serial port of a PC to the console port of the switch.

Then you can configure, maintain, and manage the switch by running Hyper Terminal in Windows OS of the PC.

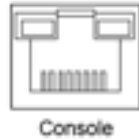

Figure 19 Console Port

One end of a DB9-RJ45 console cable is the DB9 connector to be inserted into the 9-pin serial port of a PC, and the other end is crimped RJ45 connector to be inserted into the console port of the switch.

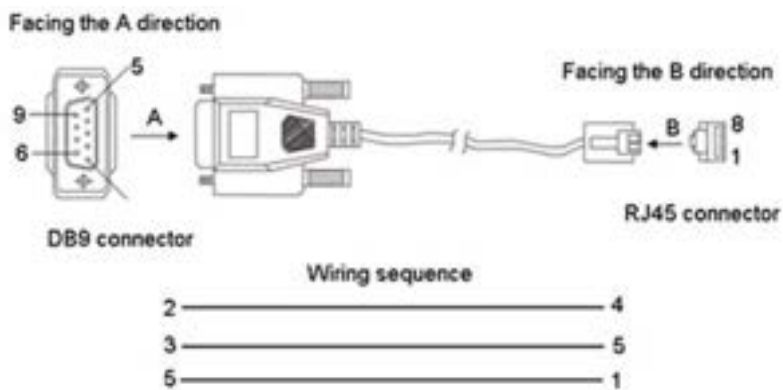

Figure 20 Wiring Sequence of DB9-RJ45 Console Cable

Table 7 Pin Definitions of DB9 Port (9-Pin Serial Port) and RJ45 Port (Console Port)

DB9 Port (9-Pin Serial Port)		RJ45 Port (Console Port)	
Pin	Signal	Pin	Signal
2	RXD (Receive data)	4	TXD (Transmit data)
3	TXD (Transmit data)	5	RXD (Receive data)
5	GND (Grounding)	1	GND (Grounding)

5 LEDs

Table 8 Front Panel LEDs

LED	State	Description
Position Satellite LED-FIX	On	The satellite has been positioned
	Off	The satellite is not positioned
Frequency Lock LED-LOCK	On	Lock status
	Off	Unlock status (Maybe initial by power on or holdover status)
Satellite Antenna Status LED	On	Normal antenna status
	Off	Wrong antenna status
Output Signal LED-OUT	On	Output enable
	Off	Output disable

6 Access

You can access the Timeserver module through web.

6.1 Access through Web

Step 1: Connect the network port of a PC to the Ethernet port of the switch with a network cable.

Step 2: Enter the IP address of the device in the address box of the browser. The user login interface is displayed. You can log in to the Web UI by default user name "admin" and password "admin".



Note:

- IE8.0 or a later version is recommended.
- For details about how to access the device and other operations, refer to the Web operation manual in the delivered CD.

Click the Navigation tree menu <Status> → <Source Status >, enter the Time Server module status display interface. As shown below , the current information of the Time Server module is displayed below.

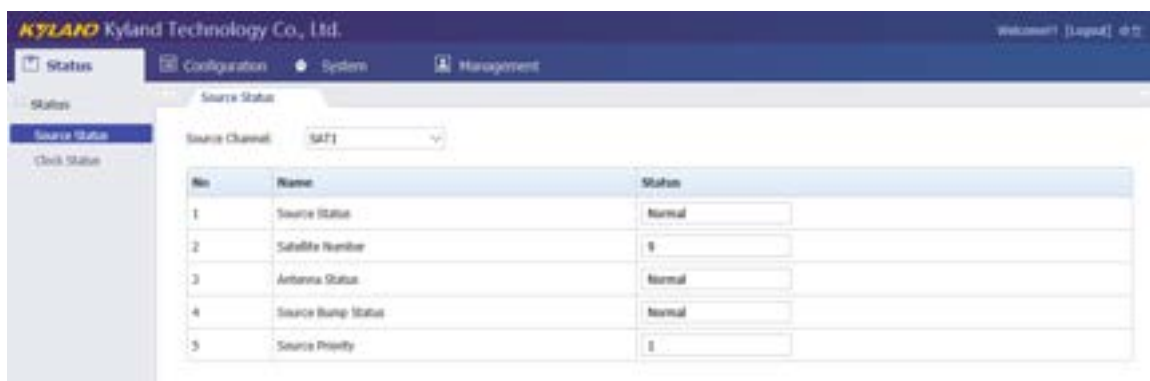

Figure 21 Time Server status display interface

7 Basic Features and Specifications

Technical specifications	Receiver	72 channel satellite receiver BD/GPS/GLONASS
	Sensitivity	Tracking Sensitivity:-167dBm Acquisition Sensitivity:-160dBm
	Oscillator	OCXO, Accuracy: 20us/24h (Constant Temp.) Aging per day $\leq 5 \times 10^{-10}$ Freq vs Temp@25°C $\leq 3 \times 10^{-9}$ Operation Temp:-20°C ~ +70°C (-4°F ~ 158°F)
Interface	Satellite input	3.3V DC, BNC connector
	Fiber input	Multi-mode 850nm or 1310nm, ST connector
	TTL output	BNC connector, IRIG-B or PPS software configurable
	RS485 output	3-Pin 3.81mm-spcing plug-in terminal block, IRIG-B or PPS software configurable
	Fiber output	multi-mode 850nm or 1310nm, ST connector, IRIG-B or PPS software configurable
	Ethernet port	1000Base-X or 100Base-FX SFP port and 100/1000Base-T(X) RJ45 port
	Console port	RS232, RJ45
LED	LEDs on front panel	Satellite positioning LED: FIX System clock lock LED: LOCK Antenna status LED: ANT Signal output LED: OUT
Power Requirements	Power input	3.3V DC
	Power terminal	A type interface (powered by backplane)
	Power consumption	<10W

Physical Characteristics	Housing	Metal
	Cooling	Natural cooling, fanless
	Dimensions (W×H×D)	122.6mm×41mm×106.6mm(4.83×1.61×4.20 in.)
	Weight	0.5Kg (1.10 pound)
Environmental limits	Operating temperature	-20°C to +70°C (-4°F to 158°F)
	Storage temperature	-40°C to +85°C (-40°F to 185°F)
	Ambient Relative Humidity	5~95% (non-condensation)
Quality assurance	Warranty	5 years
Approvals	Please visit www.kyland.com for the latest news	

KYLAND

FAX: +86-10-88796678

Website: <http://www.kyland.com>

Email: support@kyland.com

Address: Building No.2, Shixing Avenue 30#
shijingshan District, Beijing, China

For more information about KYLAND products,
please visit our website:

<http://www.kyland.com>