

AUTBUS

A Mighty Multidrop Fieldbus

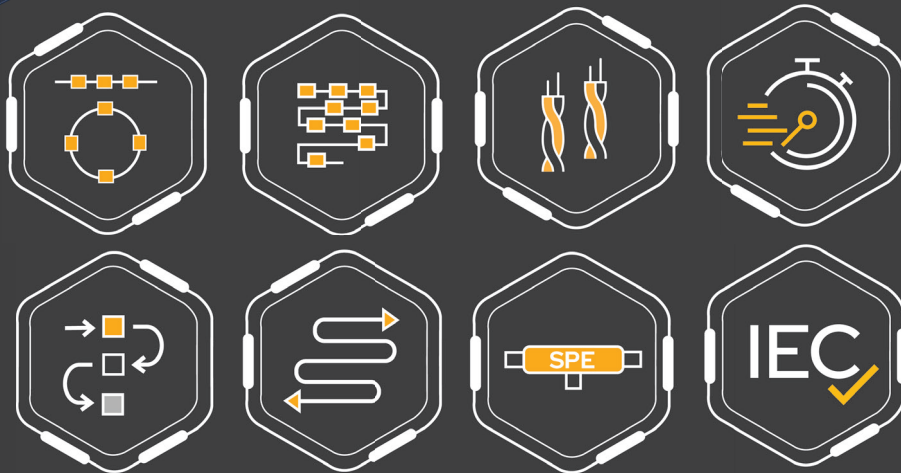

What is AUTBUS

AUTBUS is a new IEC standardized industrial broadband fieldbus invented by the company Kyland. AUTBUS can be used with balanced cables such as twisted single pair cables or unbalanced cables such as coaxial cables. With a qualified twisted pair cable, up to 254 multidrop data network nodes can be reached over a distance of up to 500 meters, at a data transmission speed of 100Mbit/s. On physical layer, AUTBUS uses OFDM technology which make it a perfect solution for communication technology in demanding environments. With its characteristics of broadband, low latency and determination, AUTBUS is predestined for the field of industrial wired data communication. In addition, AUTBUS supports data tunnelling, with which, e.g., Ethernet-based transmission protocols as well as other communication protocols like CAN Bus can be transmitted transparently from one data connection point to another via the passive multidrop data network without translating these protocols.

Key Features

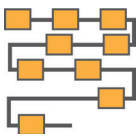

Up to 254 multidrop nodes



2 wire twisted pair cable (polarity-none sensitive)



100Mbps high data bandwidth

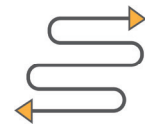

Up to 500 meters distance



Real-time deterministic

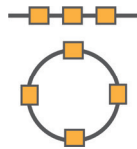

Bus and Ring Topology

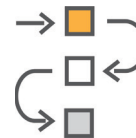

Multi-bus-protocol tunneling Ethernet, EtherNet/IP, Modbus, CAN...



SPE System Alliance cables & connectors compatible

International Standard



The AUTBUS is IEC standardized and listed under the number **IEC 61158 Type 28** and **IEC 61784 CPF22**. The International Electrotechnical Commission (IEC) is a standardization body for international standards of electrical, electronic, and information technologies to ensure safe, efficient as well as reliability operations.

Technology

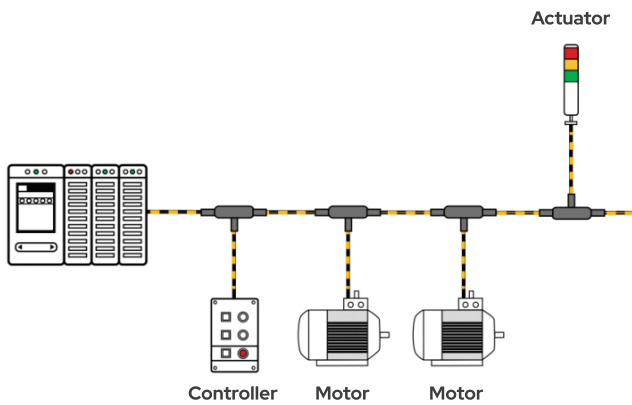

Bus Topology

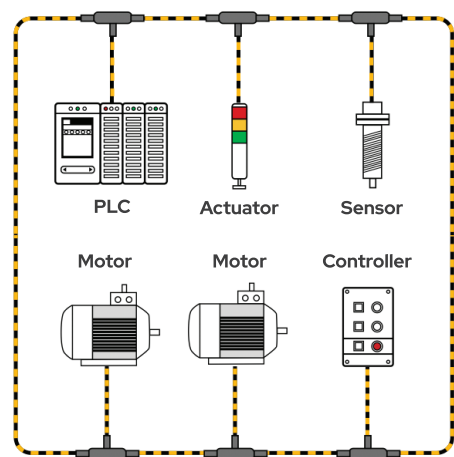

Ring Topology

On physical layer, AUTBUS uses OFDM technology (Orthogonal Frequency Division Multiplexing) to adapt channel conditions and against narrow-band interference which make AUTBUS a perfect solution for industrial communication technology in hash environment. OFDM technology has been used in wired and wireless communication. With its characteristics of broadband, low latency and determination, AUTBUS is predestined for the field of industrial wired data communication. The mission-critical deterministic challenges exist in a variety of industrial applications for which the AUTBUS can be of great benefit.

Applications

Typical applications for the AUTBUS with its multidrop data network technology can be found in factory automation, public transport, building automation, traffic control systems and also for charging station parks for electric vehicles.



ABN300 series

One port AUTBUS DIN-Rail Converter

Product Overview

ABN300 series support One (1) AUTBUS port and a variety of additional interfaces, including Ethernet, CAN and RS485. ABN300 series provides the effective transmission of multiple protocols and data types via AUTBUS networks and supports multidrop connections, long distances (up to 500m) transmission with 100Mbps system bandwidth. The ABN300 series represents an optimal communication solution for industrial sectors such as Process Automation, Oil & Gas Pipeline Management, Renewable Energy, Building Automation, Factory Automation, and Railway Construction.



Product Specification		
Interface	Protocol Bandwidth	AUTBUS, configurable, up to 100Mbps
		CAN, configurable, up to 1Mbps
		RS485, configurable, up to 10Mbps
		Ethernet, Auto Negotiation, 10/100Mbps
	Working Mode Switch	Option 0 - 15
	DIP Switch	ATB-TR: AUTBUS Terminal Resistor 100Ω
		CAN-TR: CAN Terminal Resistor 120Ω
		RS485-TR: RS485 Terminal Resistor 120Ω
	Connector Type	Terminal Block
		3-Pins M8
IEC 63171-2 IP20 SPE		
Mini USB for console		
Power Input	Power Range	DC 24 - 48V
	Consumption	3W

Mechanical	Housing	Metal, Black
	IP Level	IP30
	Weight	600g
	Dimension	30mm x 115mm x 68mm (W×H×D)
	Mounting Type	DIN-Rail
Environment	Operating Temperature	-40~70°C
	Storage Temperature	-40~85°C
	Ambient Relative Humidity	5-95% (non-condensing)
	Cooling	Fanless
Standard	EMI	FCC CFR47 Part 15
		EN55022/CISPR22, Class A
	EMC	IEC 61000 - 4 - 2 (ESD), Air: ±8kV, Contact: ±6kV
		IEC 61000 - 4 - 3 (RS), 10V/m (80MHz ~ 2GHz)
		IEC 61000 - 4 - 4 (EFT), DC Power Port: ±2kV, Singal Port: ±2kV
		IEC 61000 - 4 - 5 (Surge), Power Port: ±1kV/DM, ±2kV/CM, Singal Port: ±1kV (line to line), Singal Port: ±2kV (line to earth)
		IEC 61000 - 4 - 6 (CS), Signal ports: 0.15 ~ 230MHz at 10V/m, Power ports: 0.15 ~ 80MHz at 10V/m
	Machinery	IEC 60068 - 2 - 6 (Vibration)
		IEC60068 - 2 -27 (Shock)
		IEC60068 - 2 - 32 (Free Fall)

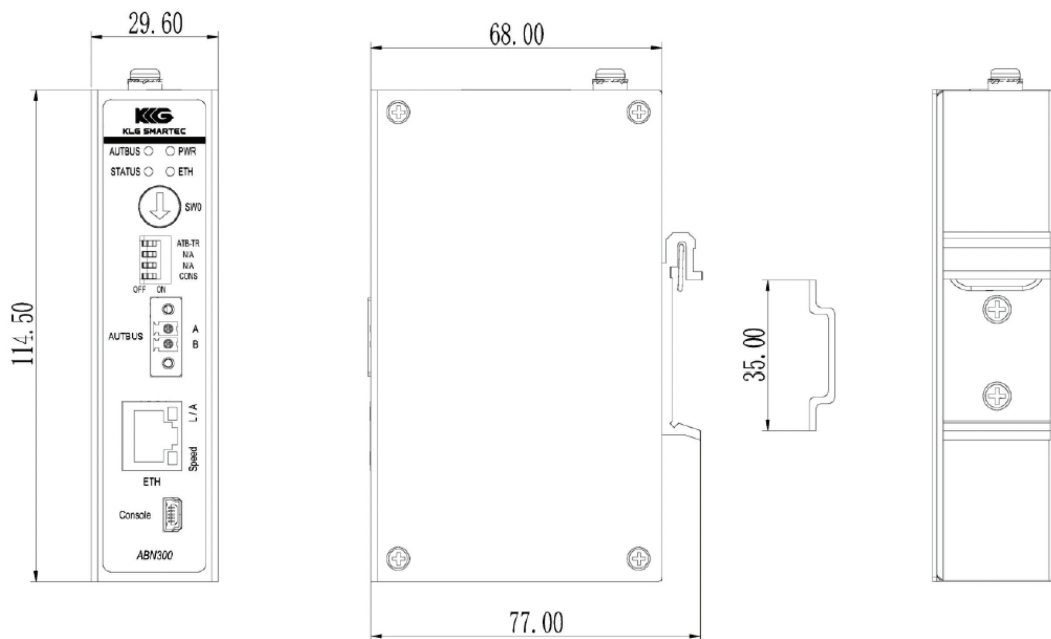

Available Models

Part Number	Product Description
ABN300-A1TB-C1TB-L2	AUTBUS to CAN converter, AUTBUS x 1 port, 2 pins x 3.81mm Terminal Block with screw interface, CAN x 1, 3 pins x 3.81mm Terminal Block with screw interface, DC 24 - 48V
ABN300-A1M8-C1TB-L2	AUTBUS to CAN converter, AUTBUS x 1 port, 3 pins M8 interface, CAN x 1, 3 pins x 3.81mm Terminal Block with screw interface, DC 24 - 48V
ABN300-A1TB-S1TB-L2	AUTBUS to RS485 converter, AUTBUS x 1 port, 2 pins x 3.81mm Terminal Block with screw interface, RS485 x 1, 3 pins x 3.81mm Terminal Block with screw interface, DC 24 - 48V
ABN300-A1M8-S1TB-L2	AUTBUS to RS485 converter, AUTBUS x 1 port, 3 pin M8 interface, RS485 x 1, 3 pins x 3.81mm Terminal Block with screw interface, DC 24 - 48V
ABN300-A1TB-E1RJ-L2	AUTBUS to Ethernet converter, AUTBUS x 1 port, 2 pins x 3.81mm Terminal Block with screw interface, 10/100M Ethernet x 1, RJ45 interface, DC 24 - 48V
ABN300-A1M8-E1RJ-L2	AUTBUS to Ethernet converter, AUTBUS x 1 port, 3 pins M8 interface, 10/100M Ethernet x 1, RJ45 interface, DC 24 - 48V
ABN300-A1SA-E1RJ-L2-L2	AUTBUS to Ethernet converter, AUTBUS x 1 port, IEC 63171-2 IP20 SPE interface, 10/100M Ethernet x 1, RJ45 interface, DC 24 - 48V, redundant power inputs

Follow us:

LinkedIn



YouTube



Website



Email: info@autbus.org

Website: www.autbus.org

Germany (Head office)

A Arbachtalstrasse 6, 72800
Eningen, Germany

T +49(0) 7121 6952 804

China

A Room 304, 3/F, Building 1, Shixing East
Street 18#, Shijingshan District,
100041 China.

T +86 10 68805639

Singapore

A 1 Jalan Kilang Timor,
#06-01 Pacific Tech Centre,
Singapore 159303

USA

A 2010 Crow Canyon Pl Suite 100
San Ramon CA 94583, USA

AUTBUS